

BRAKE PADS

MN-59

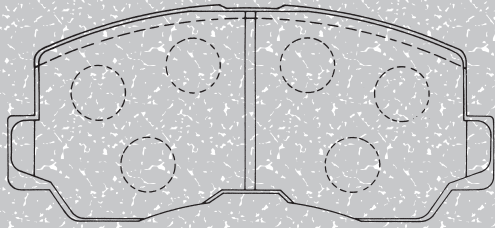

X: 127.8 Y: 49.0 Z: 15.5

MN-111

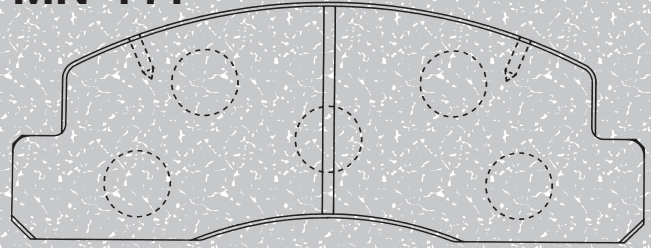

X: 166.6 Y: 57.0 Z: 18.0

MN-70

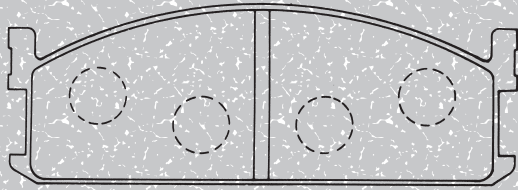

X: 133.0 Y: 47.0 Z: 15.5

MN-116

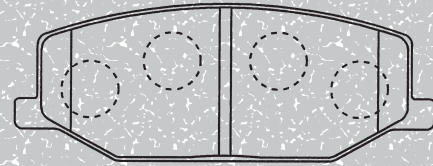

X: 110.5 Y: 41.5 Z: 14.5

MN-80

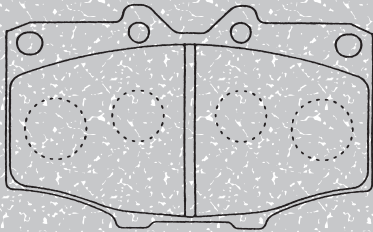

X: 107.3 Y: 56.0 Z: 15.5

MN-119

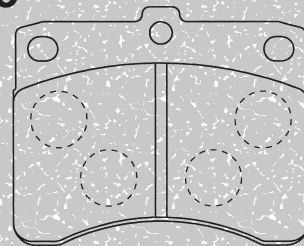

X: 78.8 Y: 57.0 Z: 13.5

MN-94

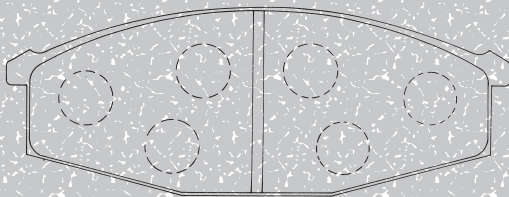

X: 142.0 Y: 53.3 Z: 16.5

MN-126M

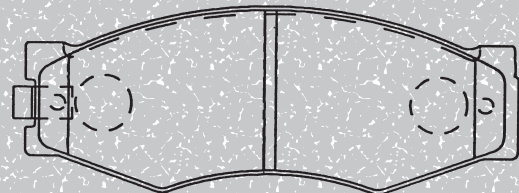

X: 130.1 Y: 44.5 Z: 16.5

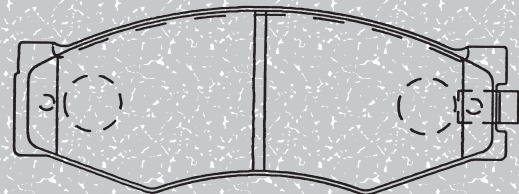

X: 130.1 Y: 44.5 Z: 16.5

MN-108

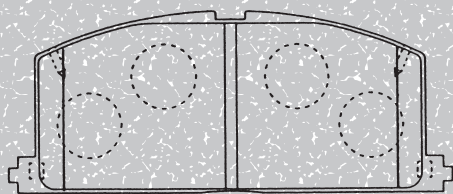

X: 119.7 Y: 45.0 Z: 15.0

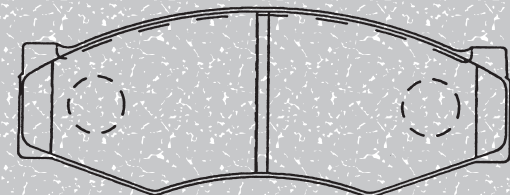

X: 130.1 Y: 44.5 Z: 16.5

BRAKE PADS

MN-128M (リヤ)

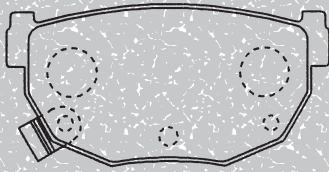

X: 85.3 Y: 41.5 Z: 14.5

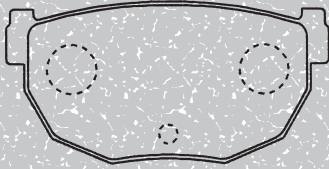

X: 85.3 Y: 41.5 Z: 14.5

パッド厚14.5mm

MN-144M

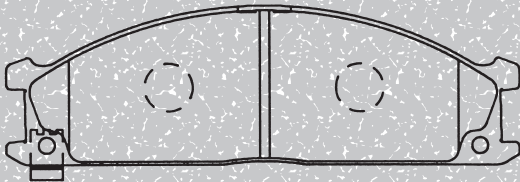

X: 160.7 Y: 48.5 Z: 17.0

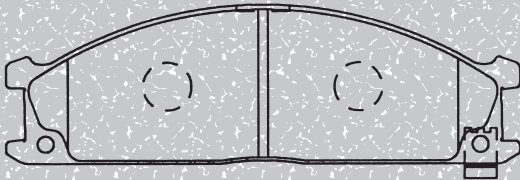

X: 160.7 Y: 48.5 Z: 17.0

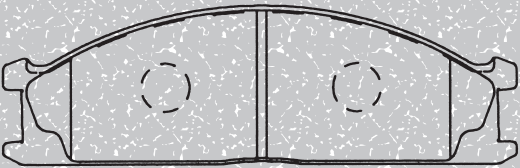

X: 160.7 Y: 48.5 Z: 17.0

MN-148

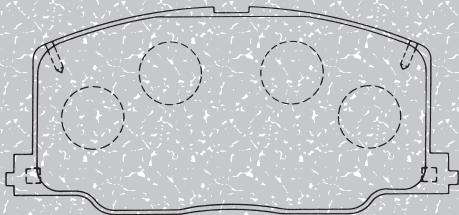

X: 119.7 Y: 51.3 Z: 15.0

MN-154 (リヤ)

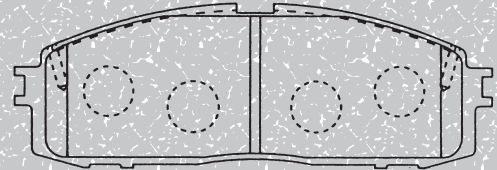

X: 125.5 Y: 37.5 Z: 15.0

MN-158M

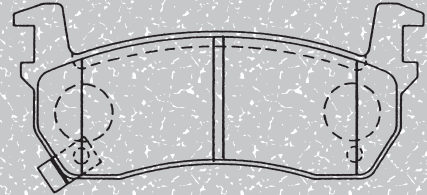

X: 108.0
Y: 34.0
Z: 16.0

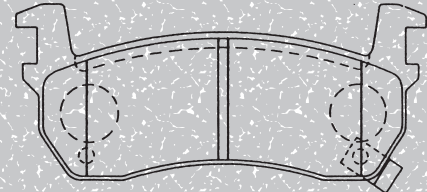

X: 108.0
Y: 34.0
Z: 16.0

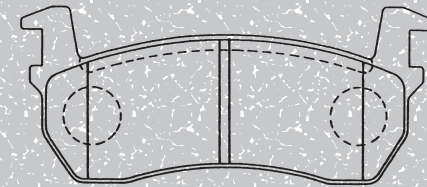

X: 108.0
Y: 34.0
Z: 16.0

MN-161M

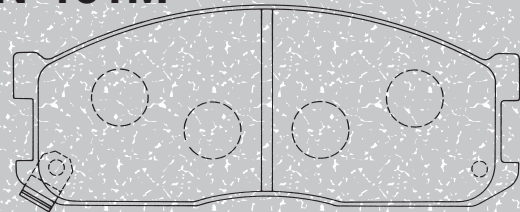

X: 133.0 Y: 50.0 Z: 15.5

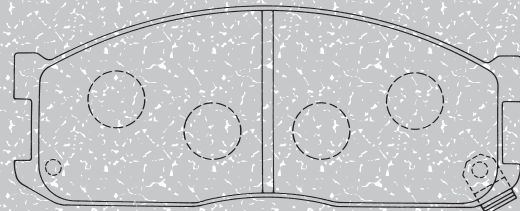

X: 133.0 Y: 50.0 Z: 15.5

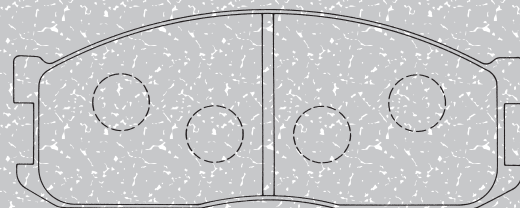

X: 133.0 Y: 50.0 Z: 15.5

BRAKE PADS

MN-162

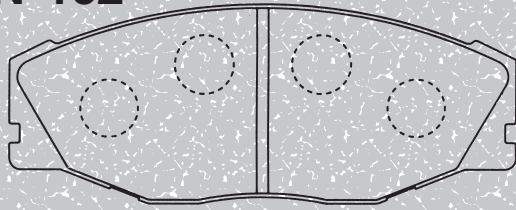

X: 133.2 Y: 50.8 Z: 15.2

MN-165 (リヤ)

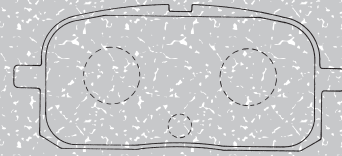

X: 86.9 Y: 35.0 Z: 12.5

MN-163M 販売中止

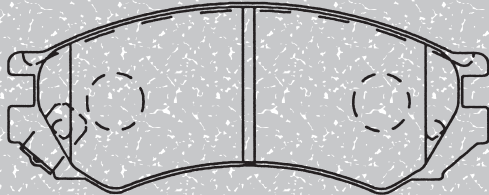

X: 128.0 Y: 43.0 Z: 15.5

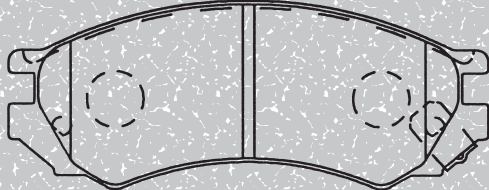

X: 128.0 Y: 43.0 Z: 15.5

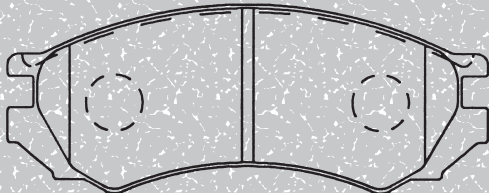

X: 128.0 Y: 43.0 Z: 15.5

MN-167M 販売中止

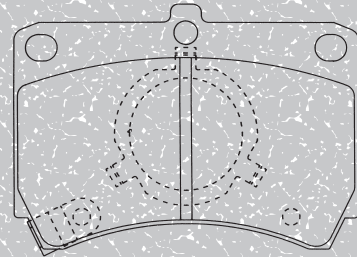

X: 91.7 Y: 57.5 Z: 15.0

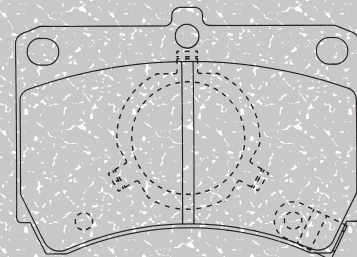

X: 91.7 Y: 57.5 Z: 15.0

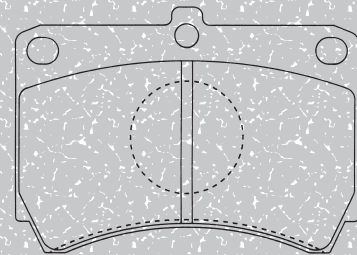

X: 91.7 Y: 57.5 Z: 15.0

MN-164M

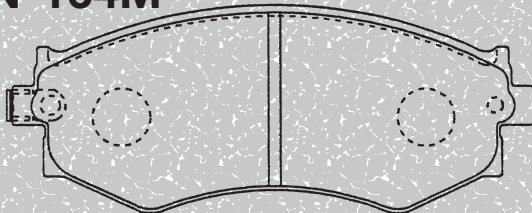

X: 137.0 Y: 48.5 Z: 17.0

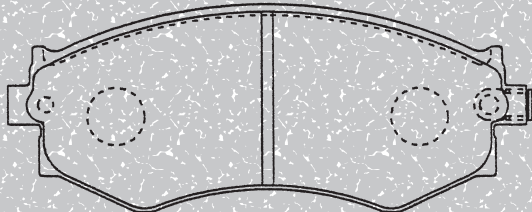

X: 137.0 Y: 48.5 Z: 17.0

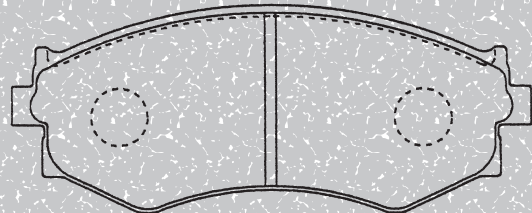

X: 137.0 Y: 48.5 Z: 17.0

MN-168 (リヤ)

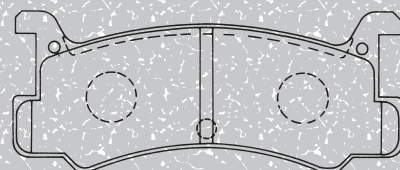

X: 101.7 Y: 32.5 Z: 12.5

BRAKE PADS

MN-170M (リヤ) 販売中止

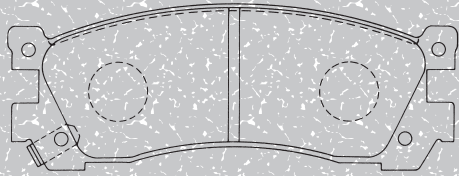

X: 117.0 Y: 37.0 Z: 13.0

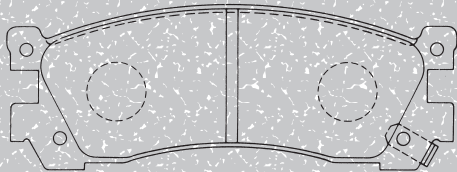

X: 117.0 Y: 37.0 Z: 13.0

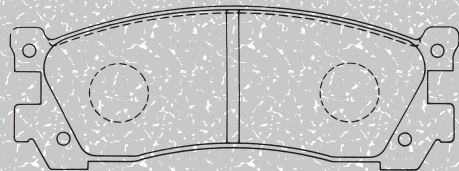

X: 117.0 Y: 37.0 Z: 13.0

MN-180 販売中止

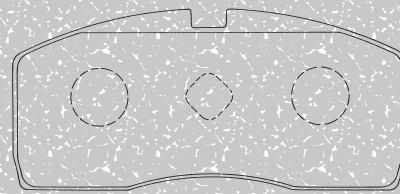

X: 102.8 Y: 39.0 Z: 14.0

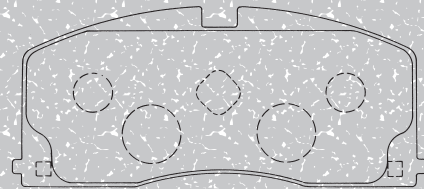

X: 108.0 Y: 39.0 Z: 14.0

MN-181 販売中止

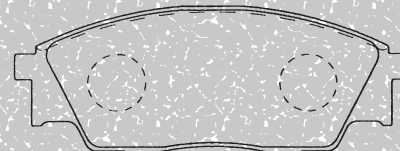

X: 103.0 Y: 37.0 Z: 14.0

MN-177 (リヤ)

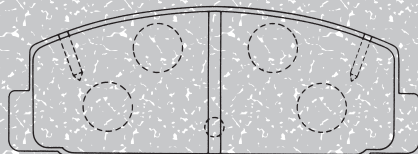

X: 107.7 Y: 39.7 Z: 13.0

MN-182M

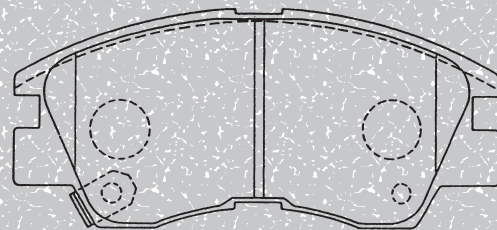

X: 127.8 Y: 49.0 Z: 17.0

MN-179M (リヤ)

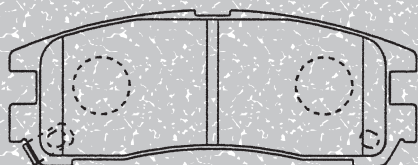

X: 107.7 Y: 35.0 Z: 15.5

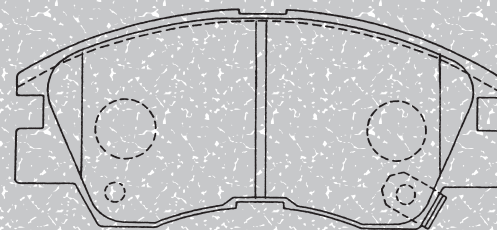

X: 127.8 Y: 49.0 Z: 17.0

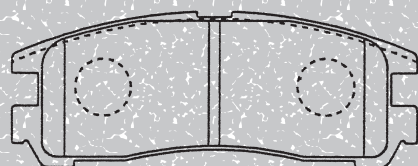

X: 107.7 Y: 35.0 Z: 15.5

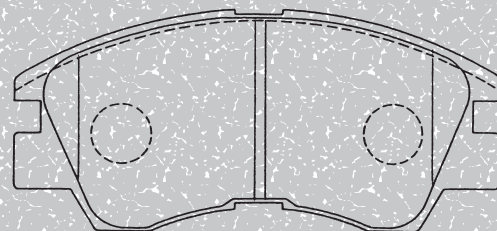

X: 127.8 Y: 49.0 Z: 17.0

BRAKE PADS

MN-183 (リヤ)

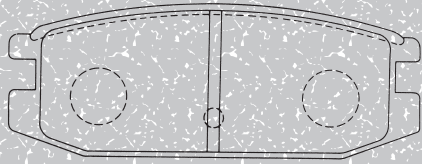

X: 107.7 Y: 40.5 Z: 13.0

MN-191

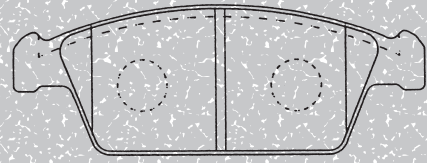

X: 108.6 Y: 39.0 Z: 14.0

MN-185M (リヤ)

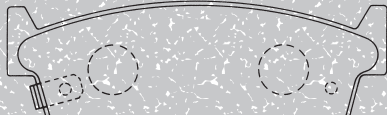

X: 98.8 Y: 34.7 Z: 15.3

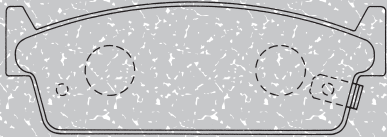

X: 98.8 Y: 34.7 Z: 15.3

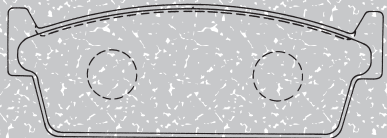

X: 98.8 Y: 34.7 Z: 15.3

MN-192

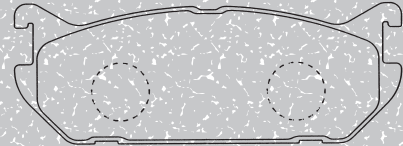

X: 102.0 Y: 35.5 Z: 14.0

MN-193M

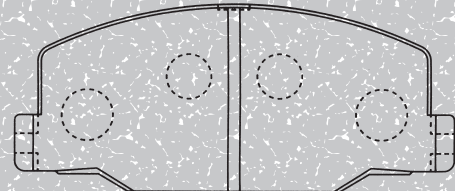

X: 128.4 Y: 55.0 Z: 15.5

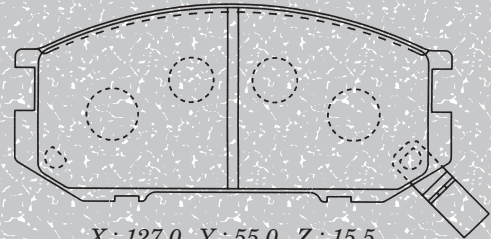

X: 127.0 Y: 55.0 Z: 15.5



X: 127.0 Y: 55.0 Z: 15.5

MN-189M (フロント&リヤ)

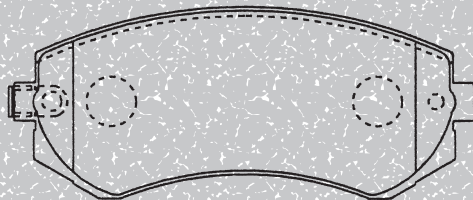

X: 121.0 Y: 44.0 Z: 15.5

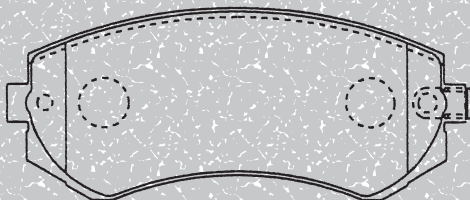

X: 121.0 Y: 44.0 Z: 15.5

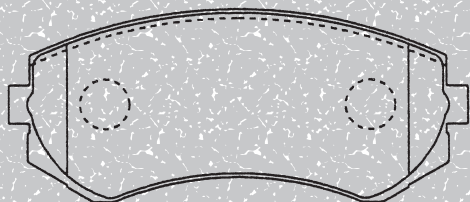

X: 121.0 Y: 44.0 Z: 15.5

BRAKE PADS

MN-194M

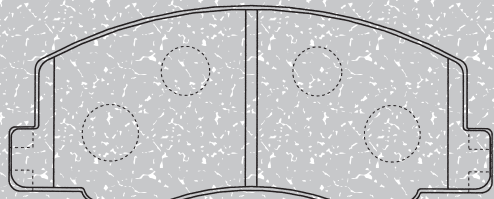

X: 128.4 Y: 49.0 Z: 15.5

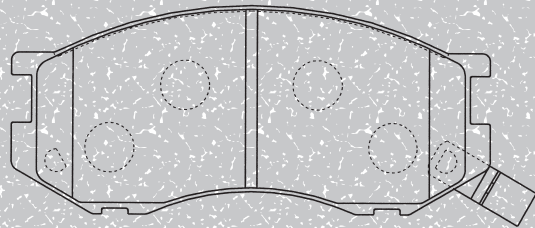

X: 126.8 Y: 49.0 Z: 15.5

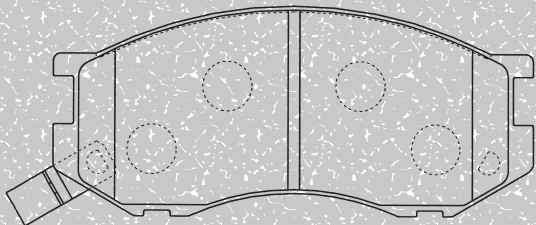

X: 126.8 Y: 49.0 Z: 15.5

MN-196M

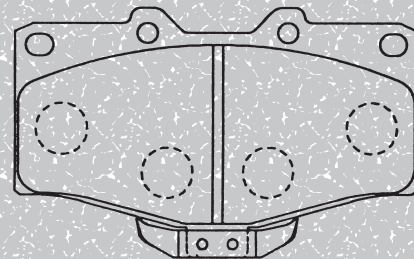

*X: 119.4
Y: 66.0
Z: 15.0*

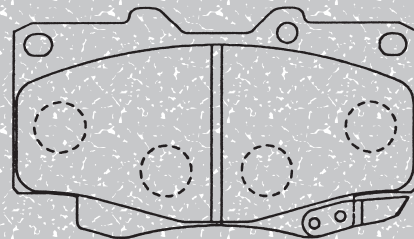

*X: 119.4
Y: 57.0
Z: 15.0*

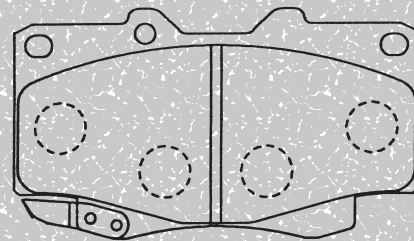

*X: 119.4
Y: 57.0
Z: 15.0*

MN-313Mと似ていますが、互換性はありません。

MN-195M 販売中止

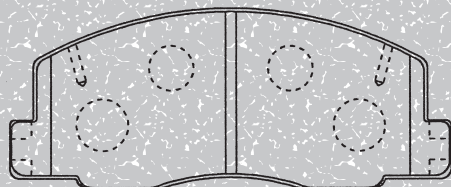

X: 128.4 Y: 49.0 Z: 15.5

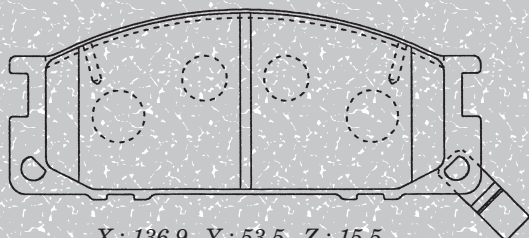

X: 136.9 Y: 53.5 Z: 15.5

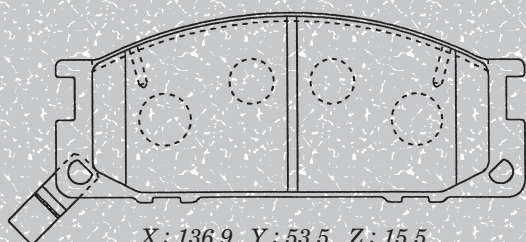

X: 136.9 Y: 53.5 Z: 15.5

MN-197M

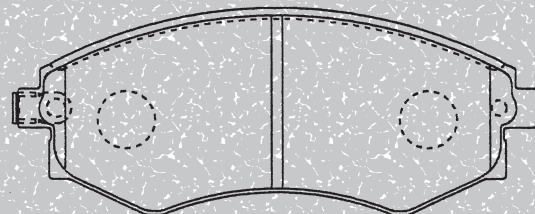

X: 137.0 Y: 48.5 Z: 16.0

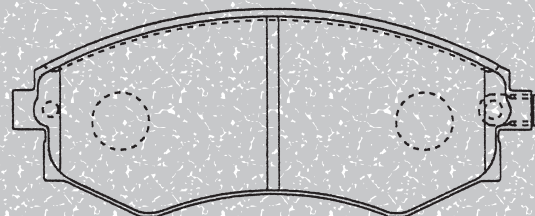

X: 137.0 Y: 48.5 Z: 16.0

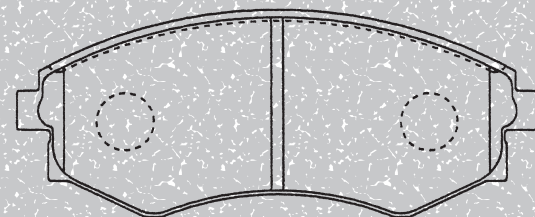

X: 137.0 Y: 48.5 Z: 16.0

BRAKE PADS

MN-198M

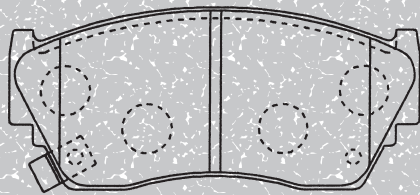

X: 108.6 Y: 44.5 Z: 16.5

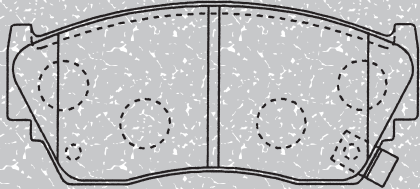

X: 108.6 Y: 44.5 Z: 16.5

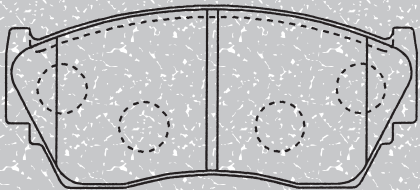

X: 108.6 Y: 44.5 Z: 16.5

MN-203M (リヤ)

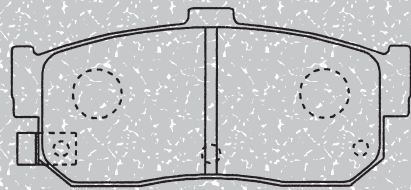

X: 105.3 Y: 45.0 Z: 16.0

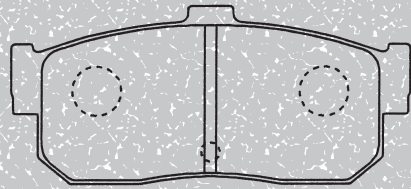

X: 105.3 Y: 45.0 Z: 16.0

MN-205

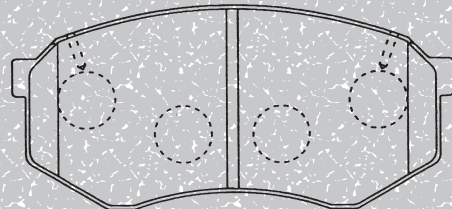

X: 116.0 Y: 49.0 Z: 15.5

MT-004と似ていますが、互換性はありません。

MN-200M (リヤ)

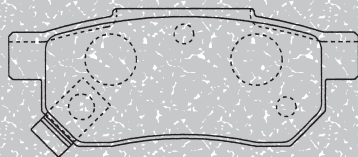

X: 88.7 Y: 33.0 Z: 13.0

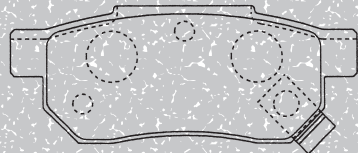

X: 88.7 Y: 33.0 Z: 13.0

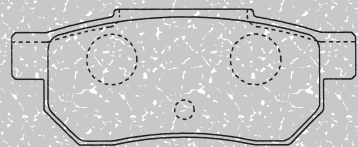

X: 88.7 Y: 33.0 Z: 13.0

MN-207M (リヤ)

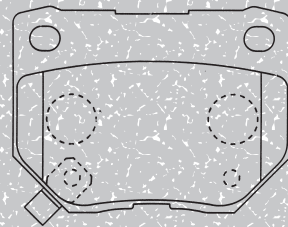

X: 73.3 Y: 50.5 Z: 16.0

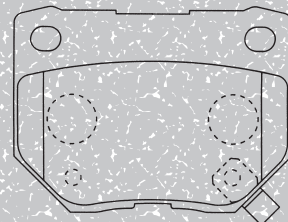

X: 73.3 Y: 50.5 Z: 16.0

MN-201

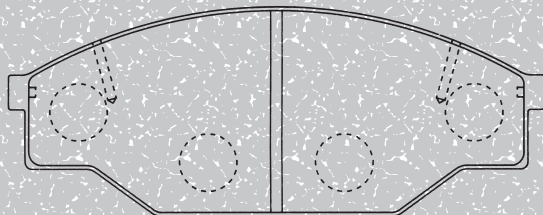

X: 140.0 Y: 55.5 Z: 15.5

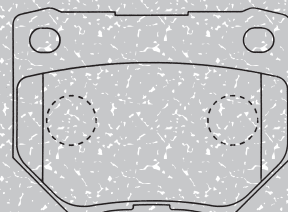

X: 73.3 Y: 50.5 Z: 16.0

BRAKE PADS

MN-208M 販売中止

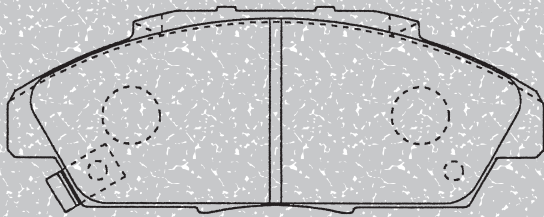

X: 141.0 Y: 51.0 Z: 18.5

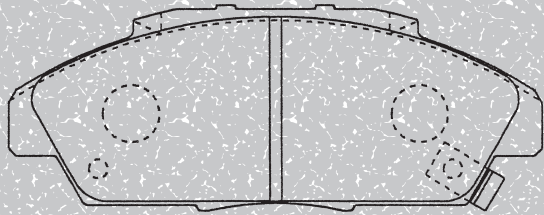

X: 141.0 Y: 51.0 Z: 18.5

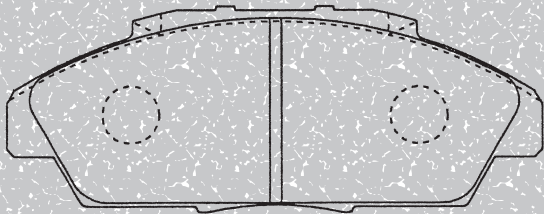

X: 141.0 Y: 51.0 Z: 18.5

MN-213M

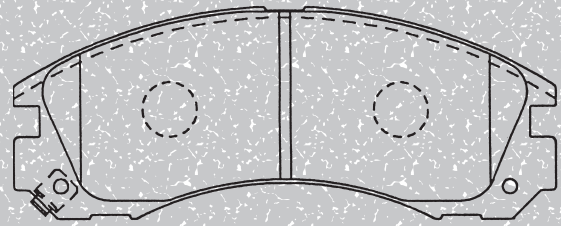

X: 149.8 Y: 47.5 Z: 16.0

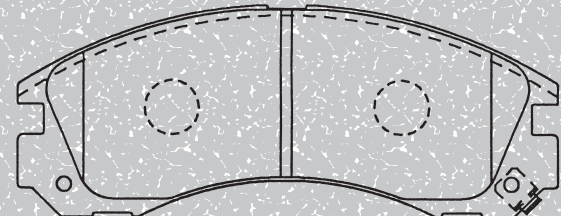

X: 149.8 Y: 47.5 Z: 16.0

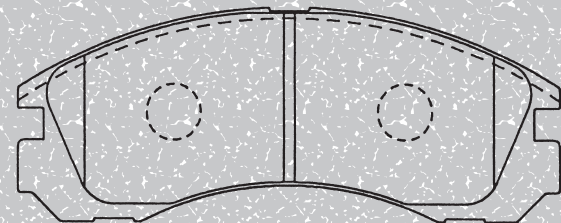

X: 149.8 Y: 47.5 Z: 16.0

MN-209

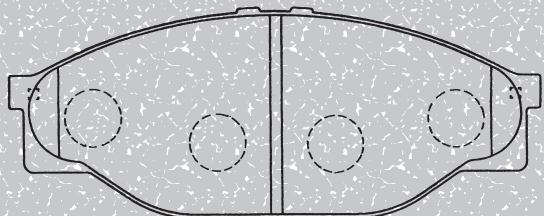

X: 140.0 Y: 54.0 Z: 15.5

MN-215

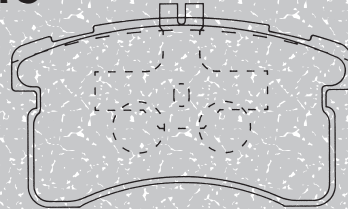

X: 88.5 Y: 42.7 Z: 14.0

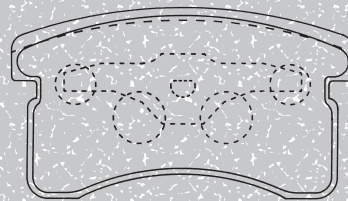

X: 88.5 Y: 42.7 Z: 14.0

MN-216

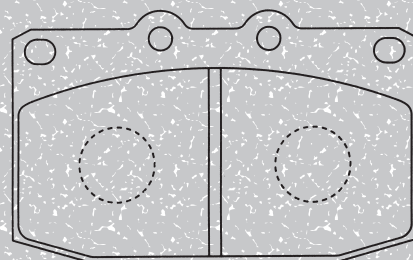

X: 106.7 Y: 63.0 Z: 15.0

BRAKE PADS

MN-217M 販売中止

X: 78.8
Y: 58.2
Z: 14.5

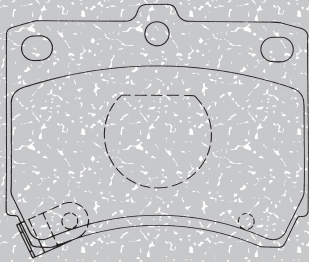

X: 78.8
Y: 58.2
Z: 14.5

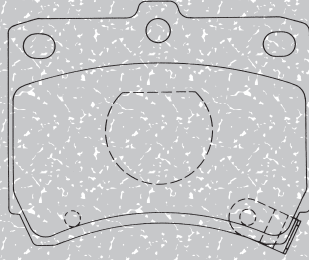

X: 78.8
Y: 56.2
Z: 14.5

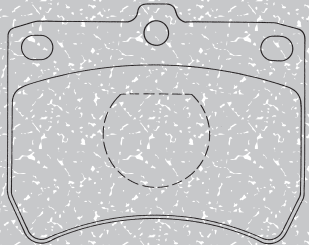

MN-220M

X: 114.8 Y: 44.0 Z: 16.0

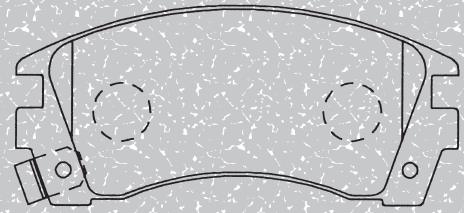

X: 114.8 Y: 44.0 Z: 16.0

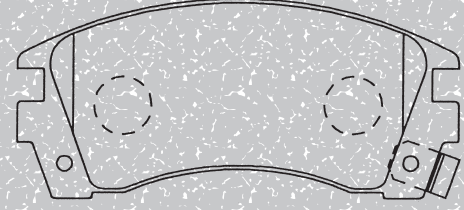

X: 114.8 Y: 44.0 Z: 16.0

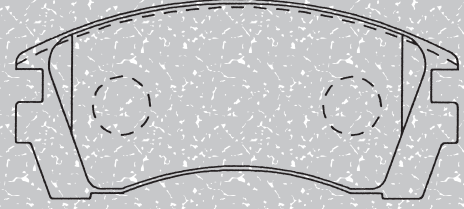

MN-218M

X: 127.8 Y: 45.5 Z: 16.0

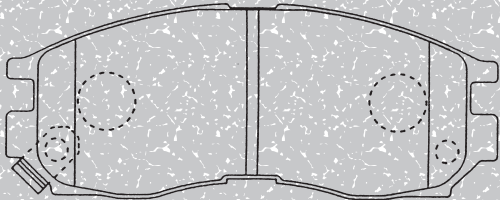

X: 127.8 Y: 45.5 Z: 16.0

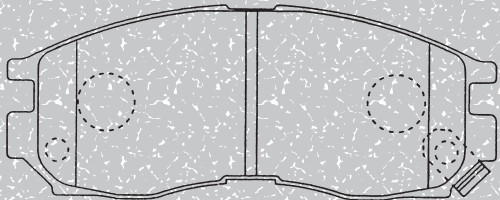

X: 127.8 Y: 45.5 Z: 16.0

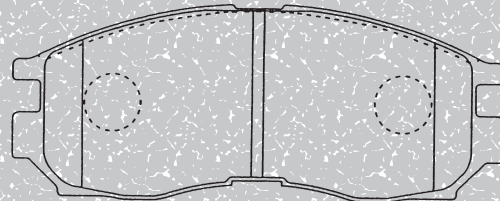

MN-221M (リヤ)

X: 98.8 Y: 29.5 Z: 16.0

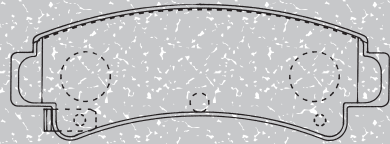

X: 98.8 Y: 29.5 Z: 16.0

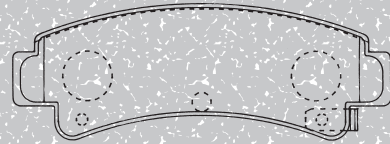

X: 98.8 Y: 29.5 Z: 16.0

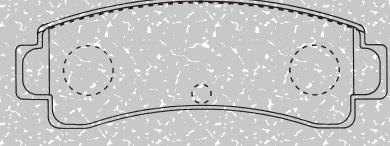

BRAKE PADS

MN-222

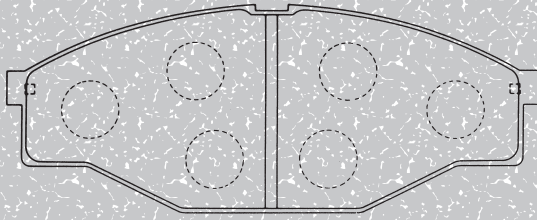

X: 140.0 Y: 53.5 Z: 15.5

MN-225

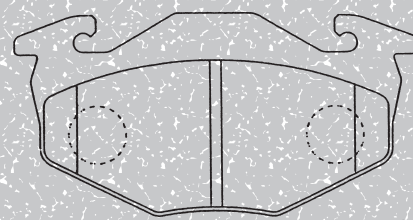

X: 105.0 Y: 52.5 Z: 15.0

MN-223M

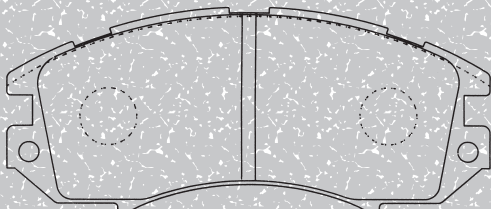

X: 127.8 Y: 45.5 Z: 17.0

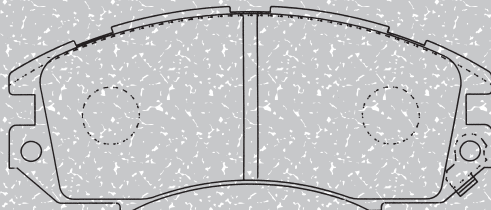

X: 127.8 Y: 45.5 Z: 17.0

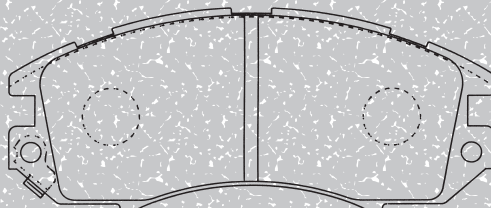

X: 127.8 Y: 45.5 Z: 17.0

MN-226M (リヤ)

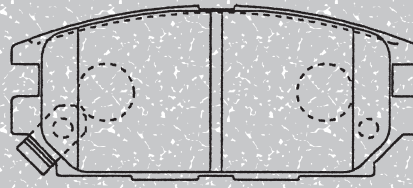

X: 107.8 Y: 44.0 Z: 15.5

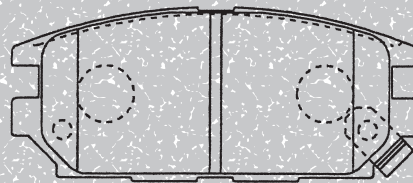

X: 107.8 Y: 44.0 Z: 15.5

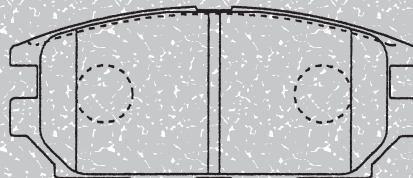

X: 107.8 Y: 44.0 Z: 15.5

MN-224M (リヤ)

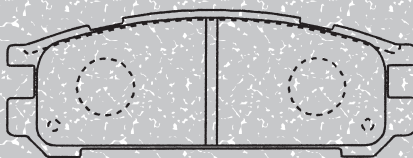

X: 107.8 Y: 36.5 Z: 15.0

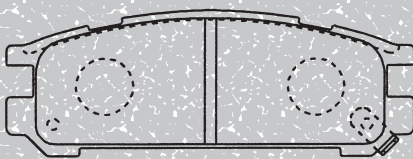

X: 107.8 Y: 36.5 Z: 15.0

BRAKE PADS

MN-227M

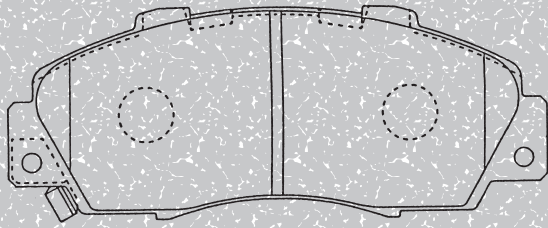

X: 148.8 Y: 52.5 Z: 17.5

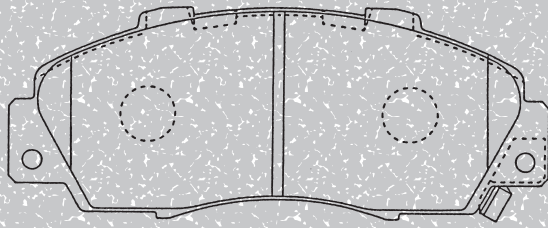

X: 148.8 Y: 52.5 Z: 17.5

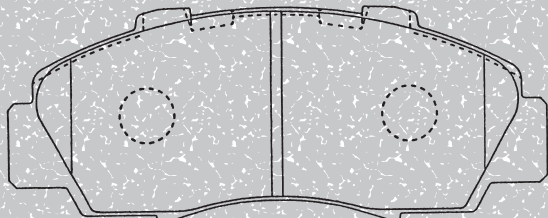

X: 148.8 Y: 52.5 Z: 17.5

MN-229

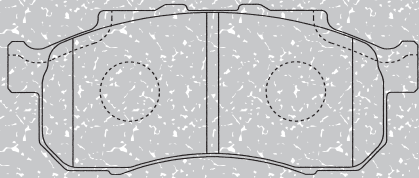

X: 103.8 Y: 37.0 Z: 14.0

MN-230

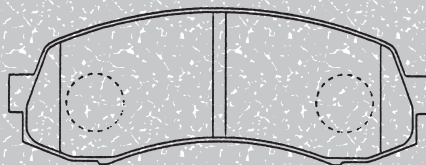

X: 111.5 Y: 35.0 Z: 14.5

MN-231

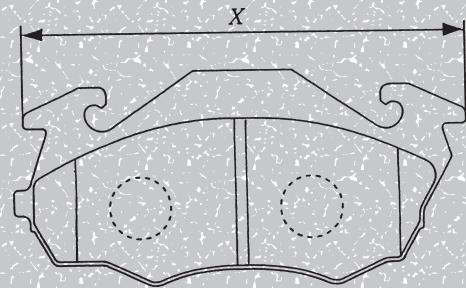

X: 115.0 Y: 49.0 Z: 15.0

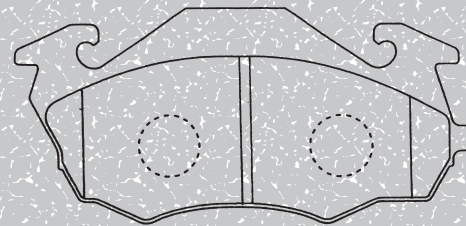

X: 115.0 Y: 49.0 Z: 15.0

MN-232

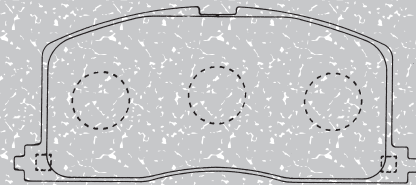

X: 106.0 Y: 41.5 Z: 13.5

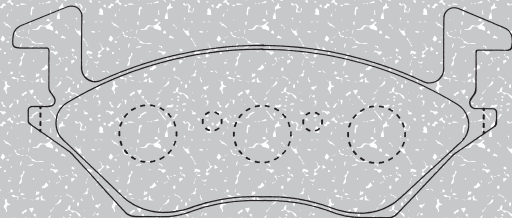

X: 132.0 Y: 40.5 Z: 13.5

MN-233

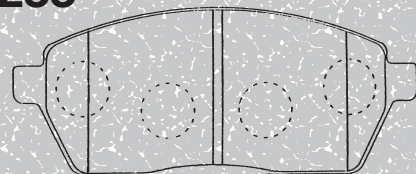

X: 102.0 Y: 40.0 Z: 15.0

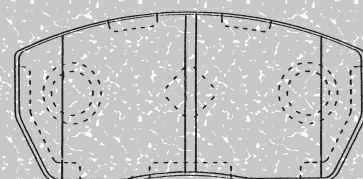

X: 88.0 Y: 38.5 Z: 15.0

BRAKE PADS

MN-234M (リヤ)

X: 98.8
Y: 34.7
Z: 15.0

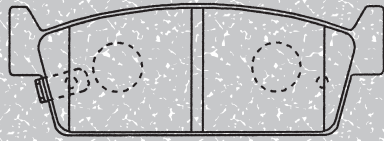

X: 98.8
Y: 34.7
Z: 15.0

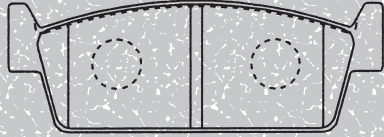

MN-238M

X: 133.2 Y: 45.5 Z: 17.5

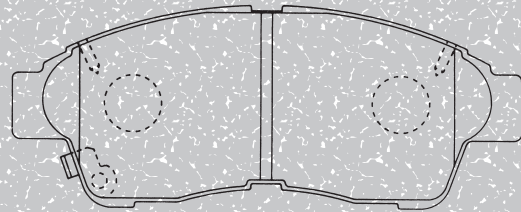

X: 133.2 Y: 45.5 Z: 17.5

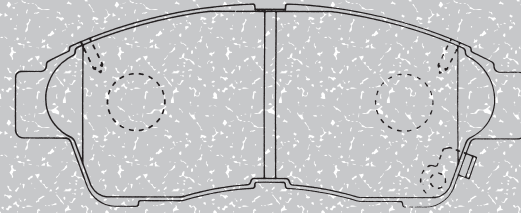

X: 133.2 Y: 45.5 Z: 17.5

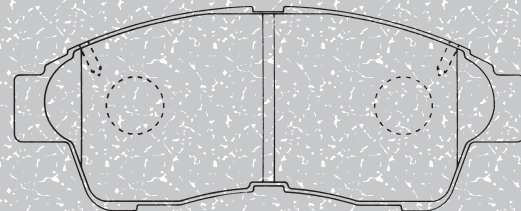

MN-235M

X: 175.6 Y: 50.0 Z: 19.0

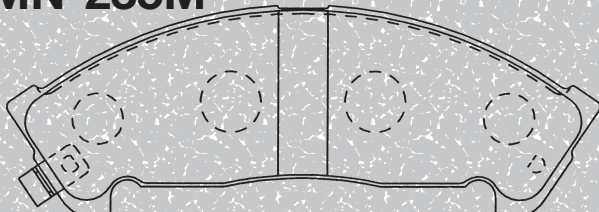

X: 175.6 Y: 50.0 Z: 19.0

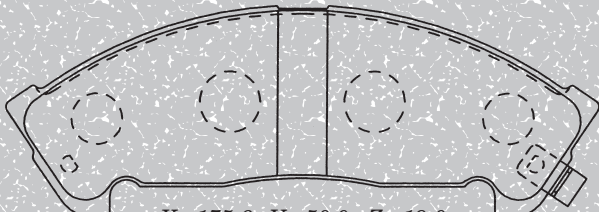

MN-239

X: 100.0 Y: 43.5 Z: 15.0

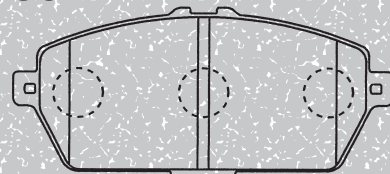

X: 95.7 Y: 42.0 Z: 15.7

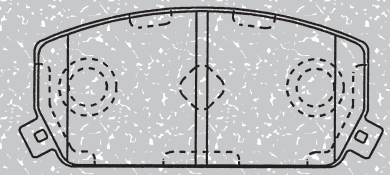

MN-236

X: 141.0 Y: 53.5 Z: 17.0

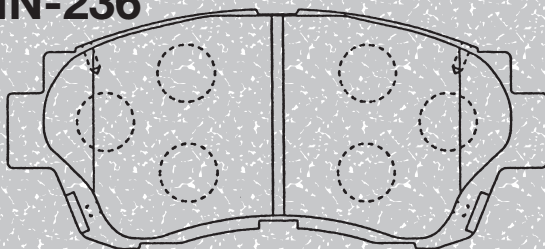

MN-237

販売中止

X: 144.5 Y: 53.0 Z: 15.5

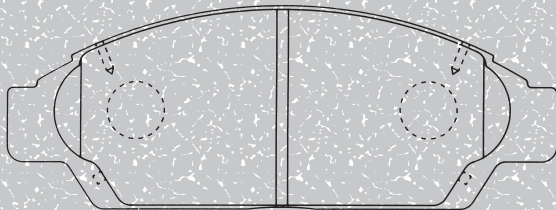

X: 144.5 Y: 45.0 Z: 15.5

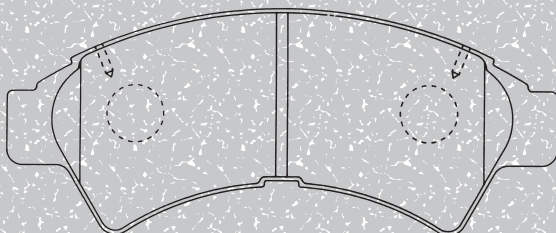

BRAKE PADS

MN-240M

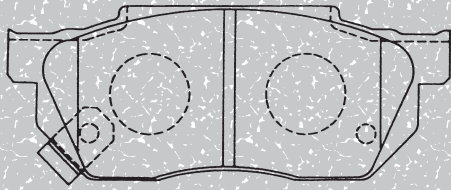

X: 116.0 Y: 43.0 Z: 15.0

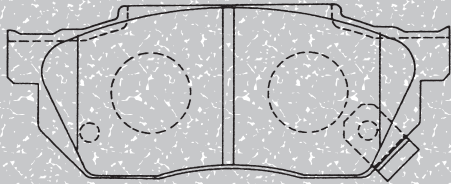

X: 116.0 Y: 43.0 Z: 15.0

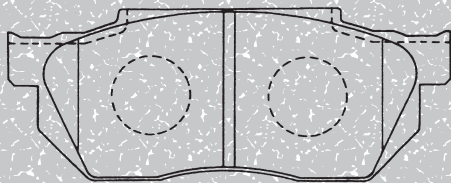

X: 116.0 Y: 43.0 Z: 15.0

MN-242M

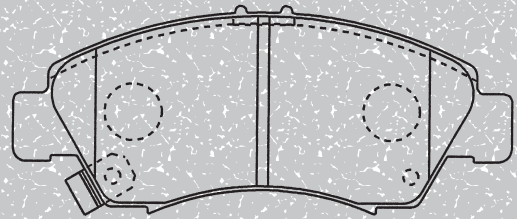

X: 131.5 Y: 47.0 Z: 15.0

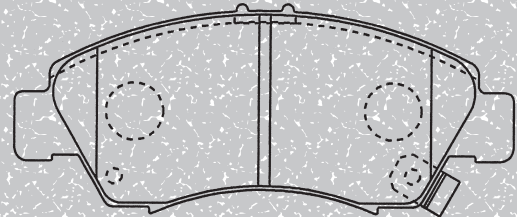

X: 131.5 Y: 47.0 Z: 15.0

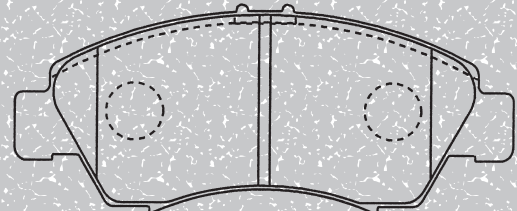

X: 131.5 Y: 47.0 Z: 15.0

MN-241M

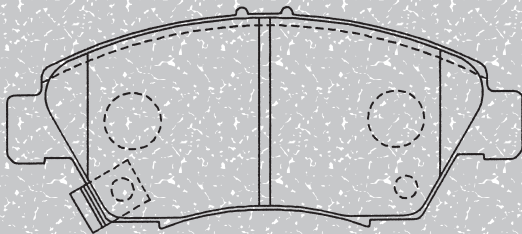

X: 136.5 Y: 51.5 Z: 16.0

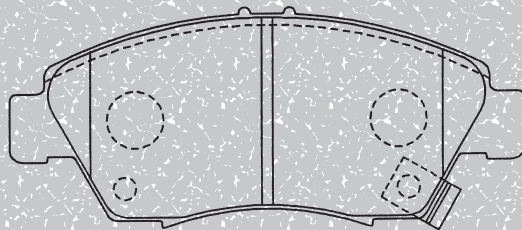

X: 136.5 Y: 51.5 Z: 16.0

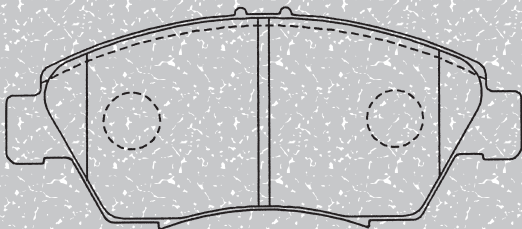

X: 136.5 Y: 51.5 Z: 16.0

MN-243

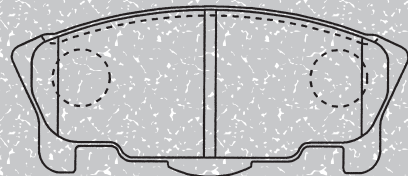

X: 104.5 Y: 45.0 Z: 14.0

MN-244

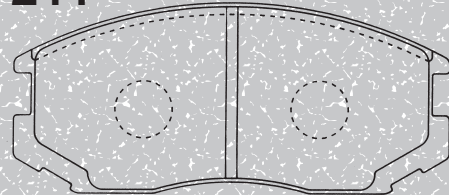

X: 114.0 Y: 47.0 Z: 15.0

BRAKE PADS

MN-247M (リヤ)

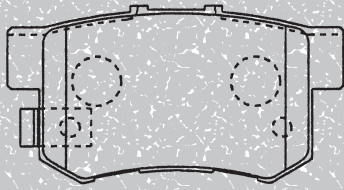

X: 88.7 Y: 42.5 Z: 14.5

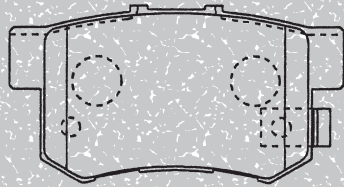

X: 88.7 Y: 42.5 Z: 14.5

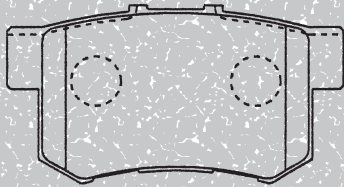

X: 88.7 Y: 42.5 Z: 14.5

MN-251M (リヤ)

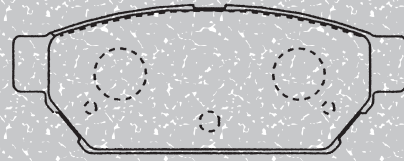

X: 98.8 Y: 36.5 Z: 14.5

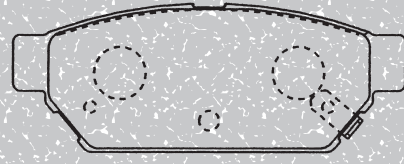

X: 98.8 Y: 36.5 Z: 14.5

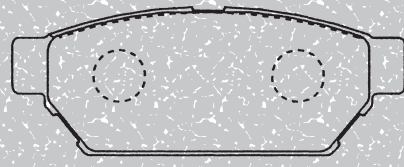

X: 98.8 Y: 36.5 Z: 14.5

MN-248M

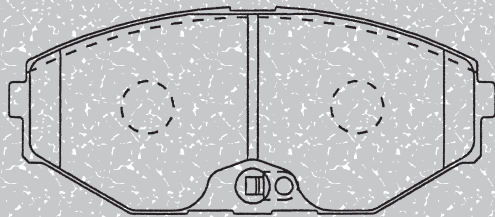

X: 139.0
Y: 58.0
Z: 15.0

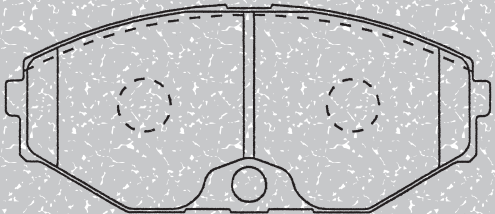

X: 139.0
Y: 58.0
Z: 15.0

MN-252M

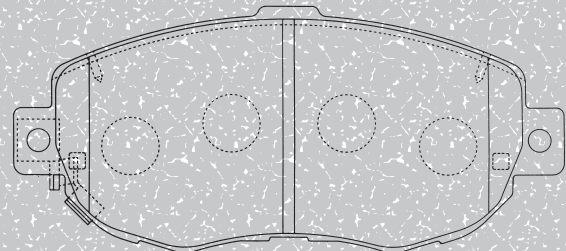

X: 144.0 Y: 59.5 Z: 17.0

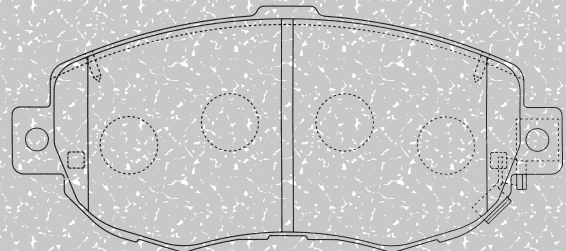

X: 144.0 Y: 59.5 Z: 17.0

MN-249M (リヤ)

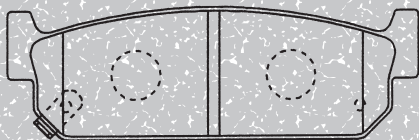

X: 108.6 Y: 35.0 Z: 15.0

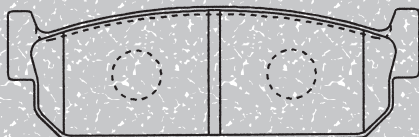

X: 108.6 Y: 35.0 Z: 15.0

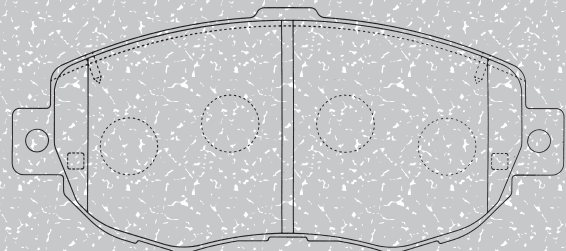

X: 144.0 Y: 59.5 Z: 17.0

BRAKE PADS

MN-253

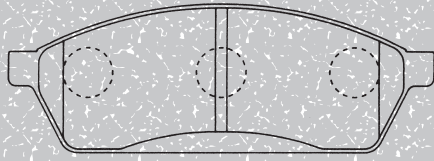

X: 112.0 Y: 39.0 Z: 14.0

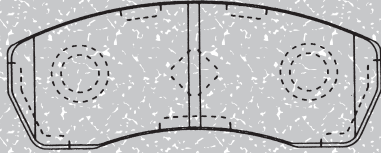

X: 98.0 Y: 34.0 Z: 14.0

MN-255M

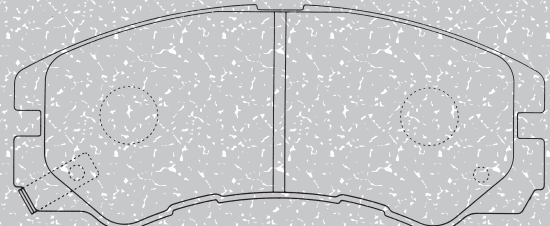

X: 137.8 Y: 49.0 Z: 16.5

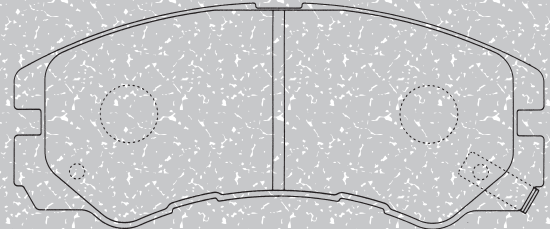

X: 137.8 Y: 49.0 Z: 16.5

MN-254M

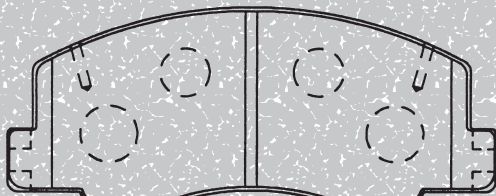

X: 128.4 Y: 49.0 Z: 15.5

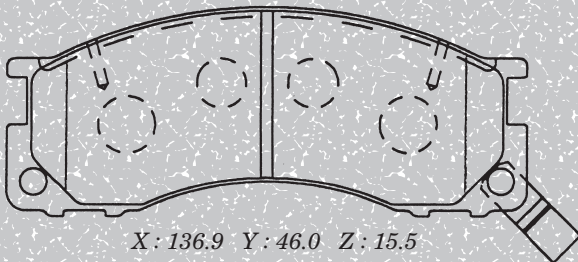

X: 136.9 Y: 46.0 Z: 15.5

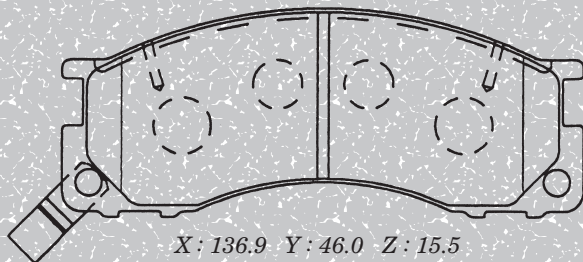

X: 136.9 Y: 46.0 Z: 15.5

MN-256M

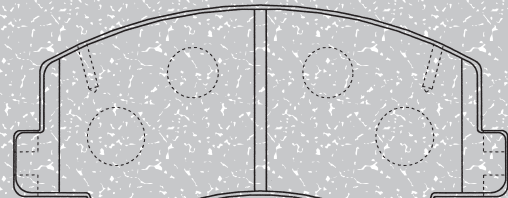

X: 128.4 Y: 49.0 Z: 15.5

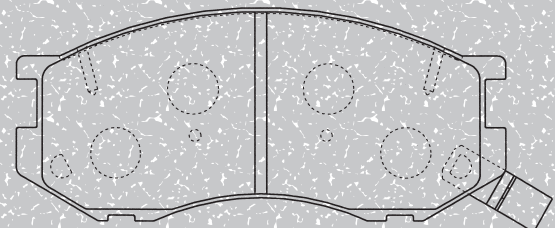

X: 126.8 Y: 49.0 Z: 15.5

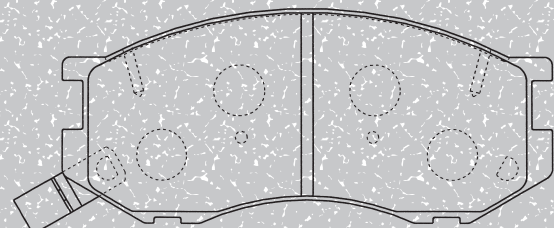

X: 126.8 Y: 49.0 Z: 15.5

BRAKE PADS

MN-257M

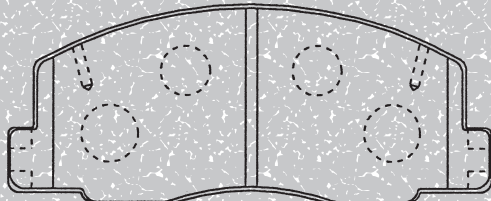

X: 128.4 Y: 49.0 Z: 15.5

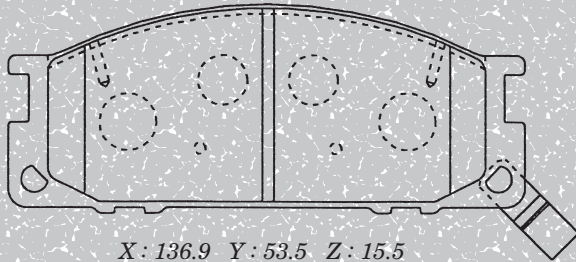

X: 136.9 Y: 53.5 Z: 15.5

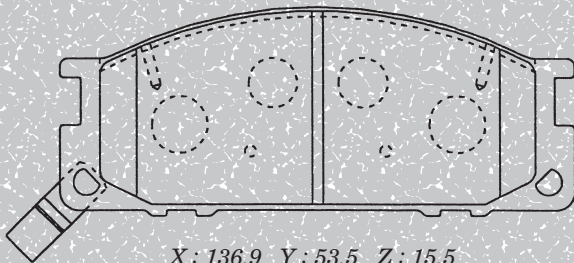

X: 136.9 Y: 53.5 Z: 15.5

MN-260M

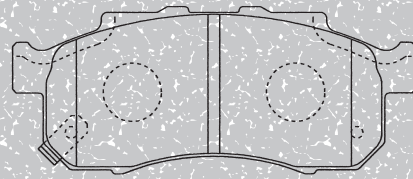

X: 103.8 Y: 37.0 Z: 14.0

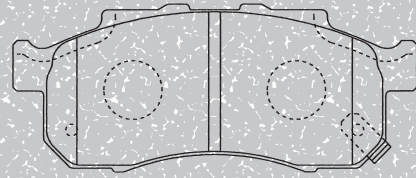

X: 103.8 Y: 37.0 Z: 14.0

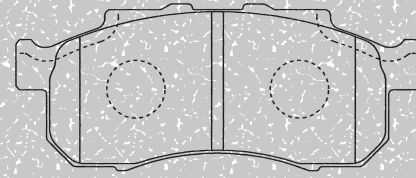

X: 103.8 Y: 37.0 Z: 14.0

MN-258M

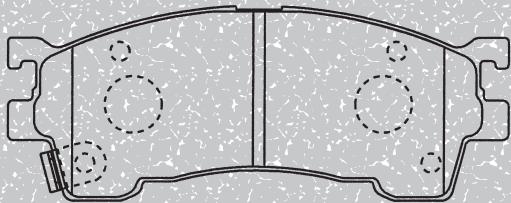

X: 132.0 Y: 42.5 Z: 15.5

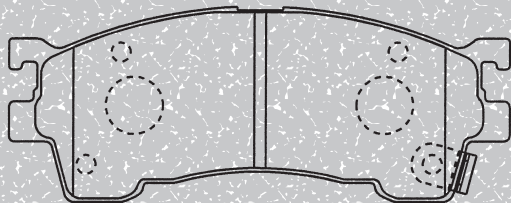

X: 132.0 Y: 42.5 Z: 15.5

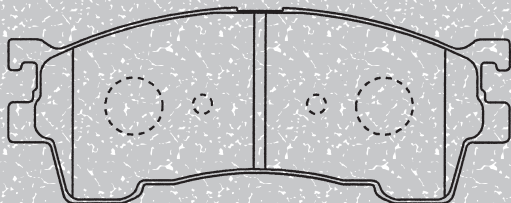

X: 132.0 Y: 42.5 Z: 14.5

MN-262 (リヤ)

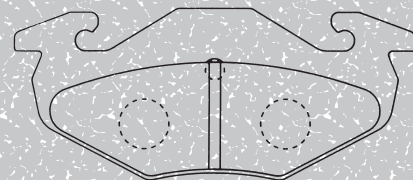

X: 105.0 Y: 42.0 Z: 12.5

MN-263

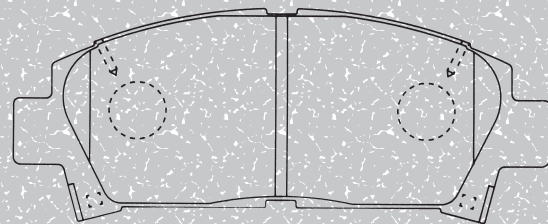

X: 141.0 Y: 49.0 Z: 15.5

BRAKE PADS

MN-264M (リヤ)

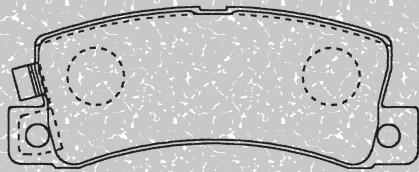

X: 107.8 Y: 35.0 Z: 15.0

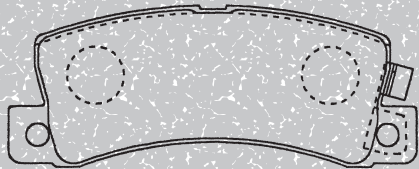

X: 107.8 Y: 35.0 Z: 15.0

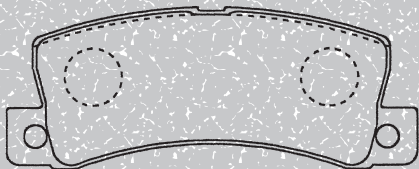

X: 107.8 Y: 35.0 Z: 15.0

MN-265M (リヤ)

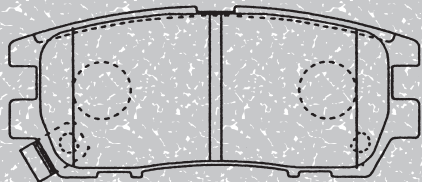

X: 107.8 Y: 40.0 Z: 14.0

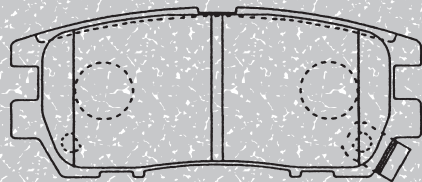

X: 107.8 Y: 40.0 Z: 14.0

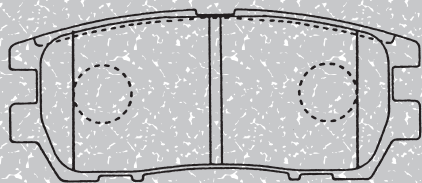

X: 107.8 Y: 40.0 Z: 14.0

MN-266

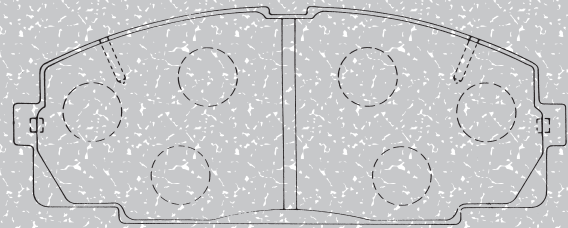

X: 145.5 Y: 55.5 Z: 15.5

MN-267M

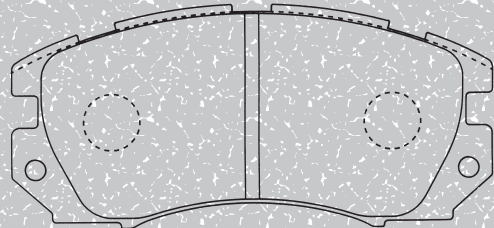

X: 127.8 Y: 51.0 Z: 17.0

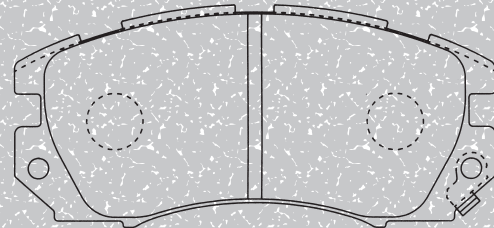

X: 127.8 Y: 51.0 Z: 17.0

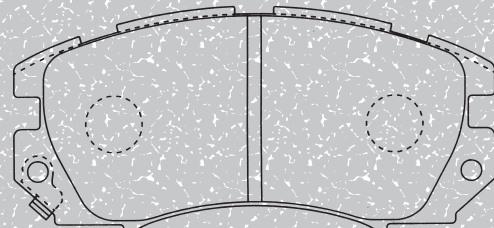

X: 127.8 Y: 51.0 Z: 17.0

BRAKE PADS

MN-268M

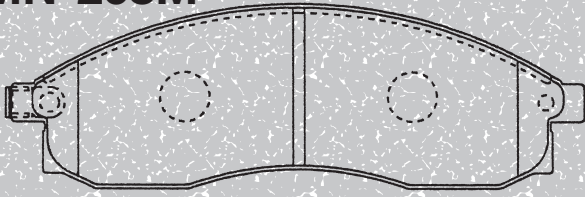

X: 151.0 Y: 43.5 Z: 17.0

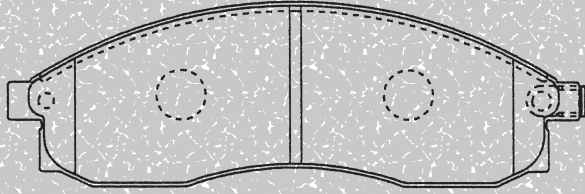

X: 151.0 Y: 43.5 Z: 17.0

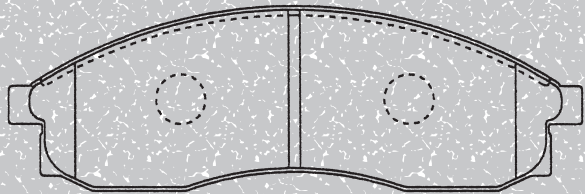

X: 151.0 Y: 43.5 Z: 17.0

MN-269

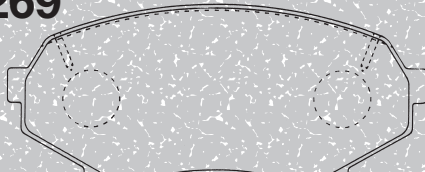

X: 110.0 Y: 44.5 Z: 14.5

MN-271M

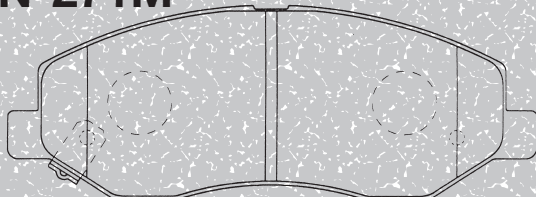

X: 139.8 Y: 47.0 Z: 17.0

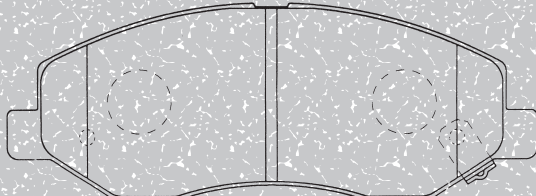

X: 139.8 Y: 47.0 Z: 17.0

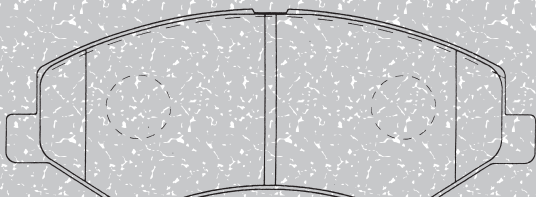

X: 139.8 Y: 47.0 Z: 17.0

MN-272M

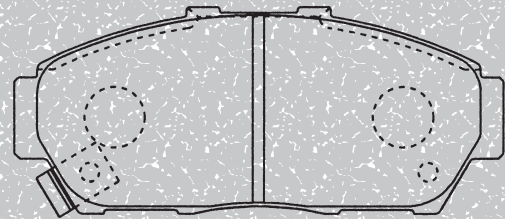

X: 129.0 Y: 51.2 Z: 16.0

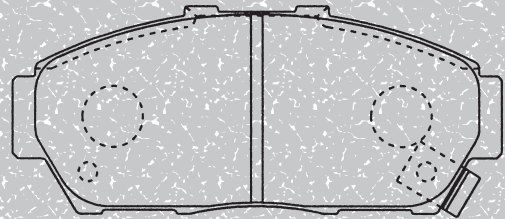

X: 129.0 Y: 51.2 Z: 16.0

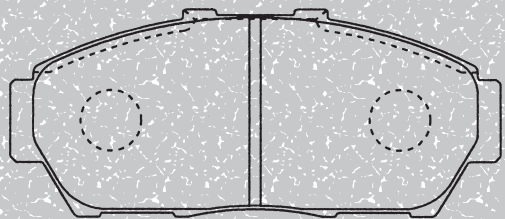

X: 129.0 Y: 51.2 Z: 16.0

MN-273M

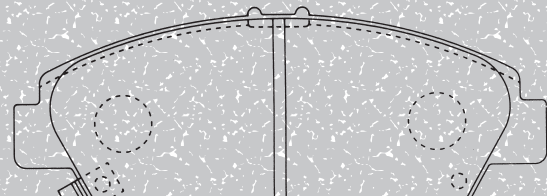

X: 137.8 Y: 50.0 Z: 18.5

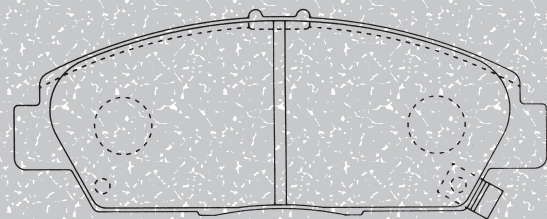

X: 137.8 Y: 50.0 Z: 18.5

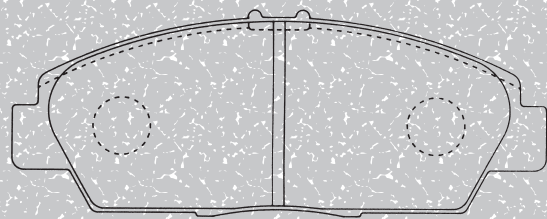

X: 137.8 Y: 50.0 Z: 18.5

BRAKE PADS

MN-274M

X: 119.4
Y: 68.5
Z: 15.0

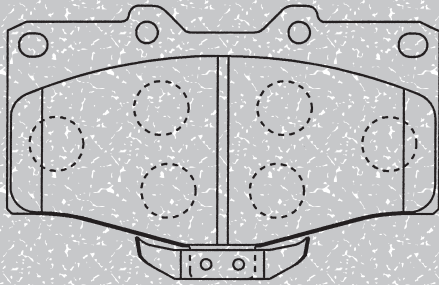

X: 119.4
Y: 60.0
Z: 15.0

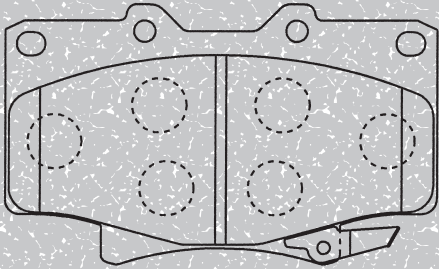

X: 119.4
Y: 60.0
Z: 15.0

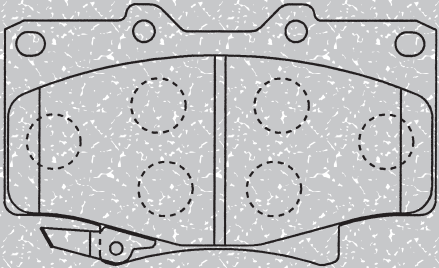

MN-276M

X: 108.6 Y: 41.5 Z: 16.0

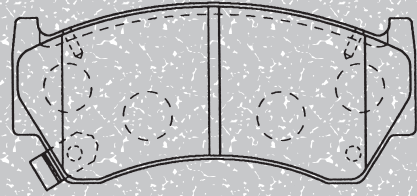

X: 108.6 Y: 41.5 Z: 16.0

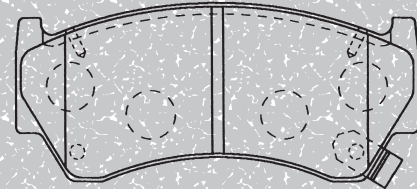

X: 108.6 Y: 41.5 Z: 16.0

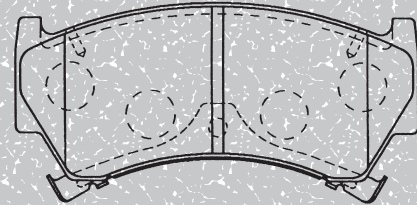

MN-275M (リヤ)

X: 106.0 Y: 35.0 Z: 17.5

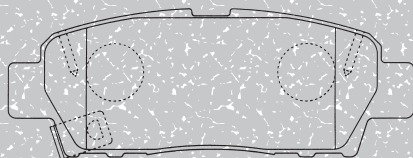

X: 106.0 Y: 35.0 Z: 17.5

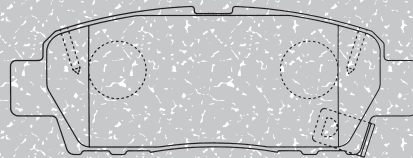

X: 106.0 Y: 35.0 Z: 17.5

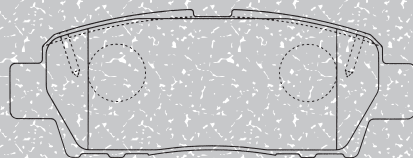

MN-277M (リヤ) 販売中止

X: 99.5 Y: 34.0 Z: 15.0



X: 99.5 Y: 34.0 Z: 15.0

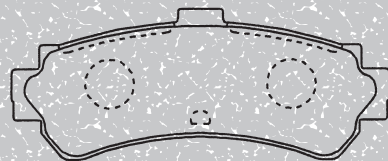

BRAKE PADS

MN-278 (リヤ)

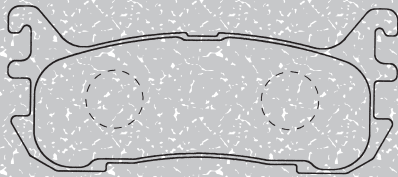

X: 102.0 Y: 31.5 Z: 12.5

MN-281 (リヤ)

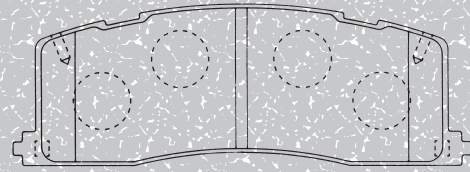

X: 119.7 Y: 39.0 Z: 15.5

MN-279M

*X: 107.3
Y: 67.0
Z: 15.5*

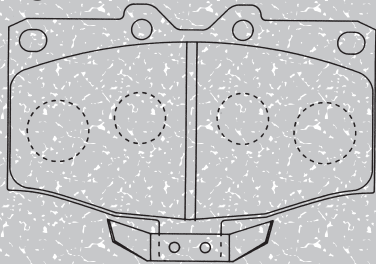

*X: 107.3
Y: 59.5
Z: 15.5*

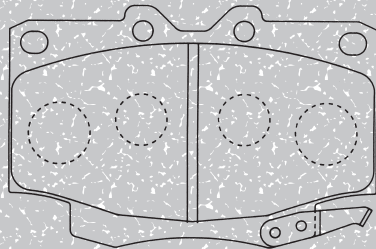

*X: 107.3
Y: 59.5
Z: 15.5*

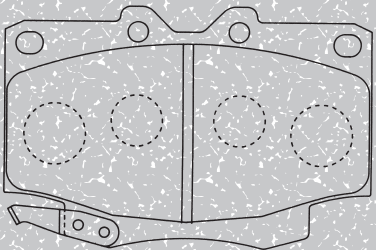

MN-282M

X: 177.2 Y: 57.0 Z: 20.0

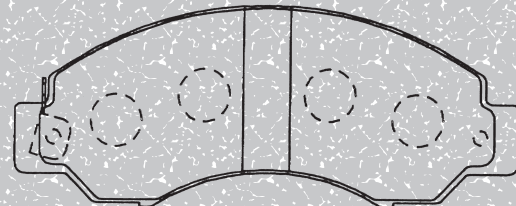

X: 177.2 Y: 57.0 Z: 20.0

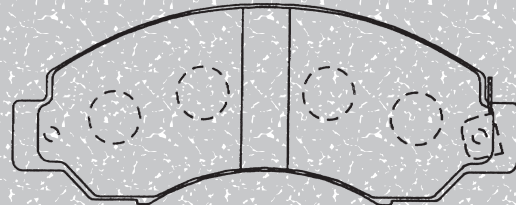

X: 177.2 Y: 57.0 Z: 20.0

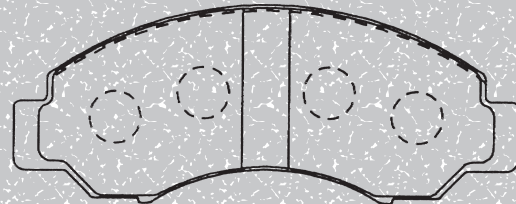

MN-280M (リヤ)

X: 109.6 Y: 39.0 Z: 16.0

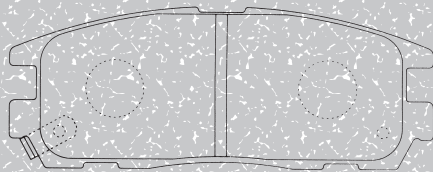

X: 109.6 Y: 39.0 Z: 16.0

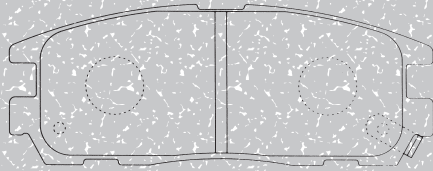

X: 109.6 Y: 39.0 Z: 16.0

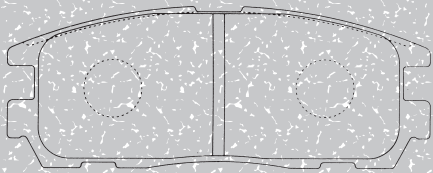

MN-283

X: 108.6 Y: 38.0 Z: 15.0

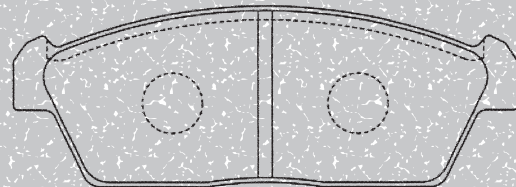

BRAKE PADS

MN-284M

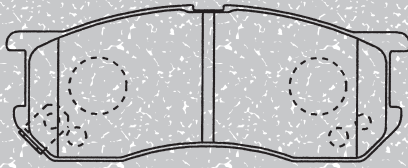

X: 106.0 Y: 36.0 Z: 15.0

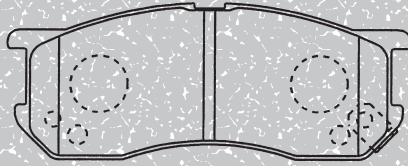

X: 106.0 Y: 36.0 Z: 15.0

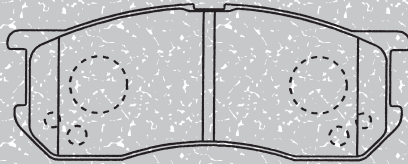

X: 106.0 Y: 36.0 Z: 15.0

MN-288M (リヤ)

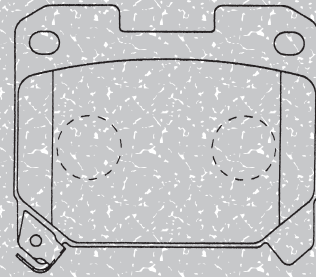

X: 80.8
Y: 57.5
Z: 16.5

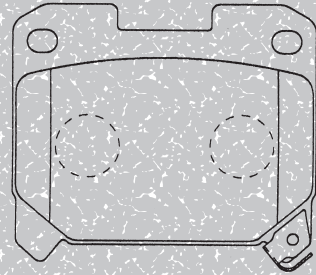

X: 80.8
Y: 57.5
Z: 16.5

MN-285

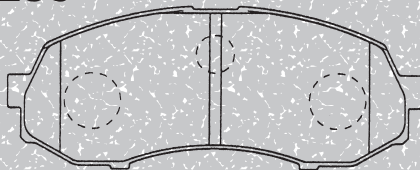

X: 110.0 Y: 37.5 Z: 14.5

MN-290

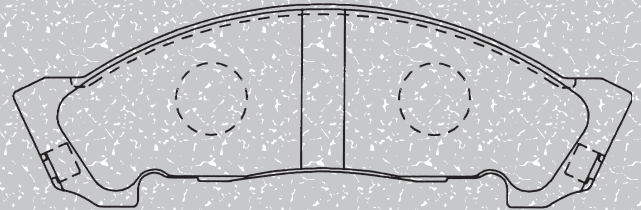

X: 191.2 Y: 51.0 Z: 21.0

MN-286

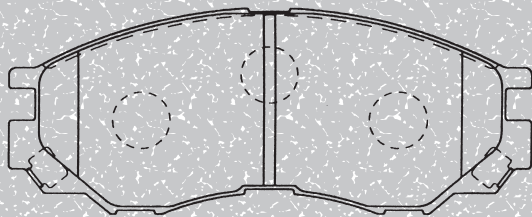

X: 137.8 Y: 47.5 Z: 16.0

MN-291M

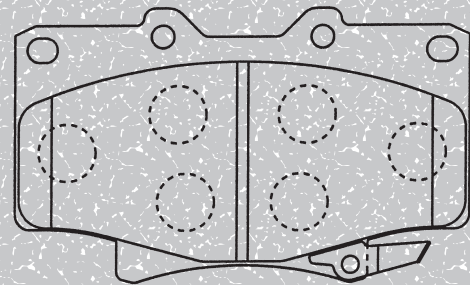

X: 119.4 Y: 60.0 Z: 15.0

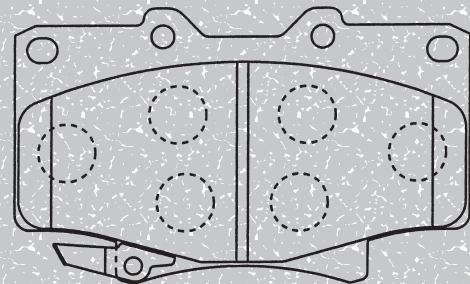

X: 119.4 Y: 60.0 Z: 15.0

BRAKE PADS

MN-292M (リヤ)

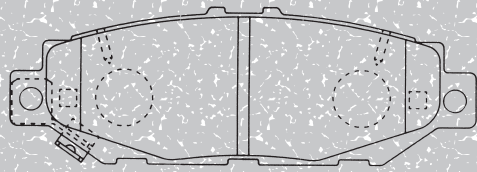

X: 121.9 Y: 38.0 Z: 15.5

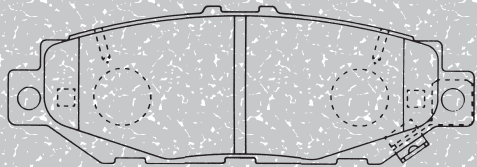

X: 121.9 Y: 38.0 Z: 15.5

MN-294M

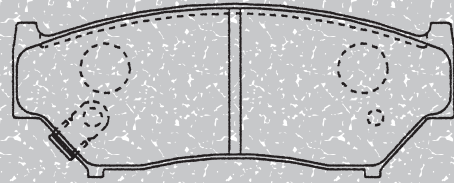

X: 116.5 Y: 40.5 Z: 15.5

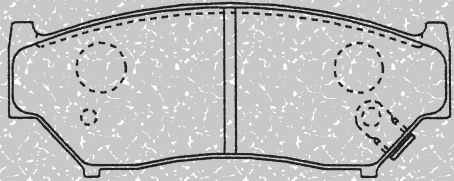

X: 116.5 Y: 40.5 Z: 15.5

MN-293M (リヤ)

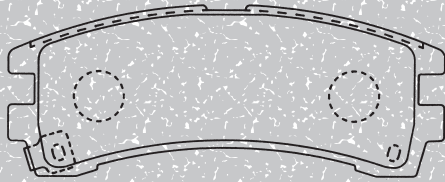

X: 114.8 Y: 35.7 Z: 16.0

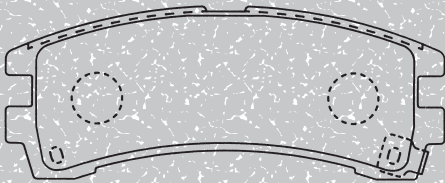

X: 114.8 Y: 35.7 Z: 16.0

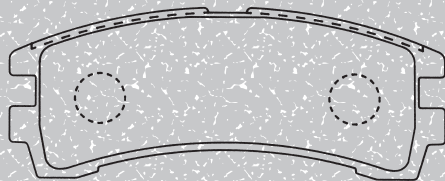

X: 114.8 Y: 35.7 Z: 16.0

MN-295M 販売中止

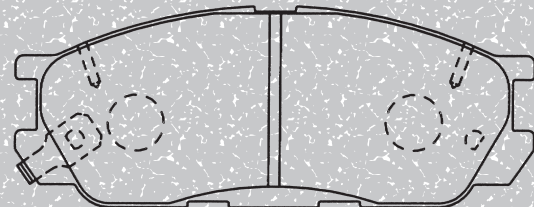

X: 138.0 Y: 52.0 Z: 16.0

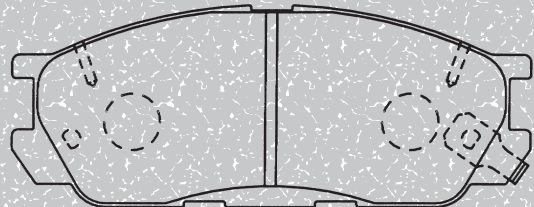

X: 138.0 Y: 52.0 Z: 16.0

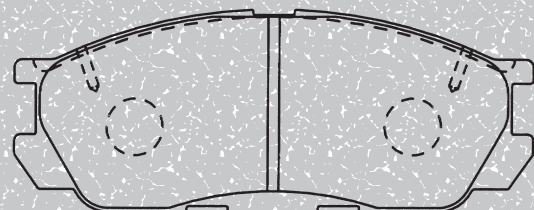

X: 138.0 Y: 52.0 Z: 16.0

BRAKE PADS

MN-296M 販売中止

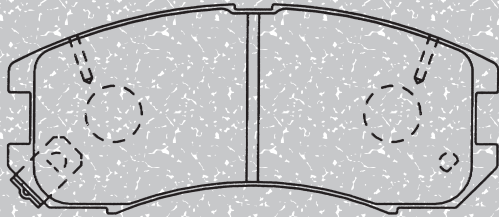

X: 130.0 Y: 46.5 Z: 16.0

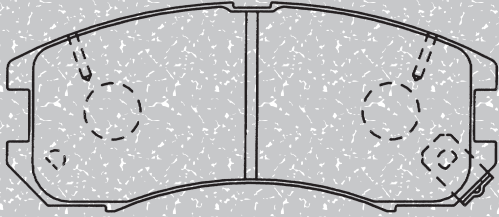

X: 130.0 Y: 46.5 Z: 16.0

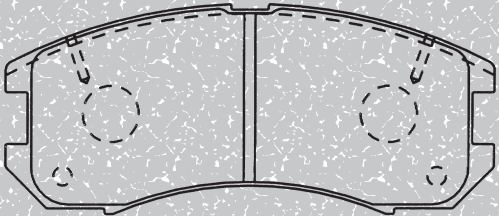

X: 130.0 Y: 46.5 Z: 15.0

MN-297M

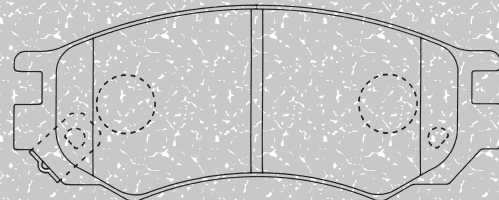

X: 127.7 Y: 45.0 Z: 15.0

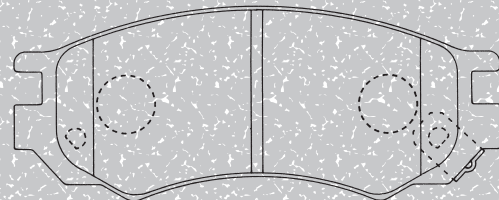

X: 127.7 Y: 45.0 Z: 15.0

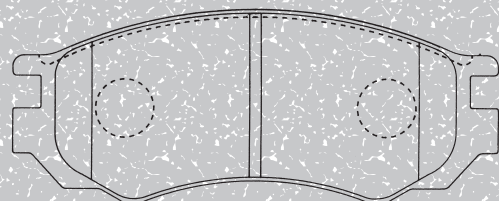

X: 127.7 Y: 45.0 Z: 15.0

MN-298

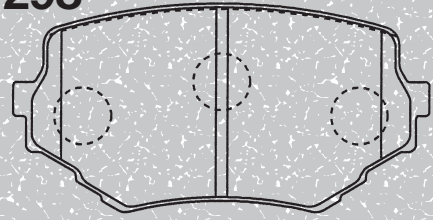

X: 110.0 Y: 52.0 Z: 14.5

MN-299M

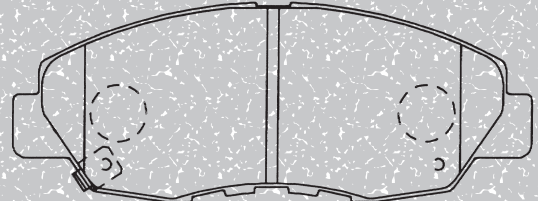

X: 137.8 Y: 47.5 Z: 16.5

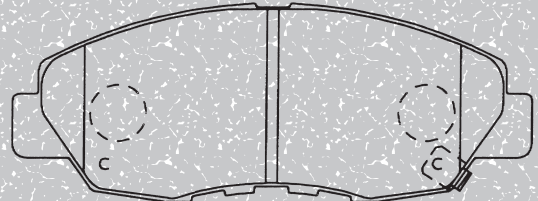

X: 137.8 Y: 47.5 Z: 16.5

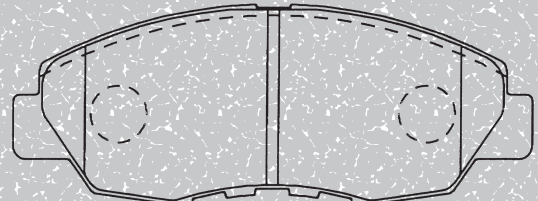

X: 137.8 Y: 47.5 Z: 16.5

MN-301 (リヤ)

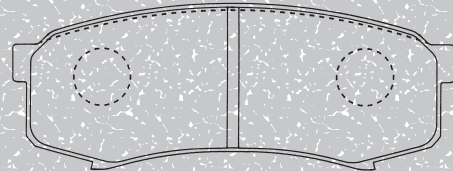

X: 116.0 Y: 39.0 Z: 15.5

MN-302

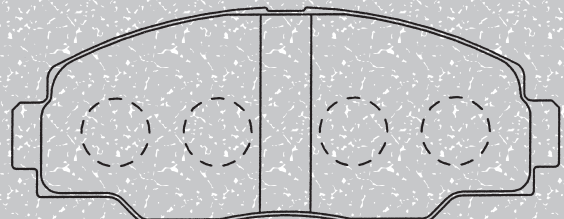

X: 144.5 Y: 54.0 Z: 15.5

BRAKE PADS

MN-303M (リヤ)

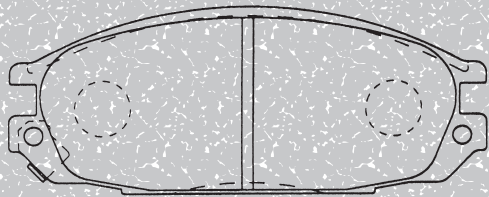

X: 128.0 Y: 50.5 Z: 19.0

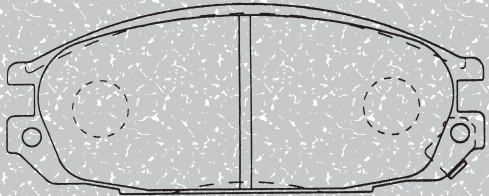

X: 128.0 Y: 50.5 Z: 19.0

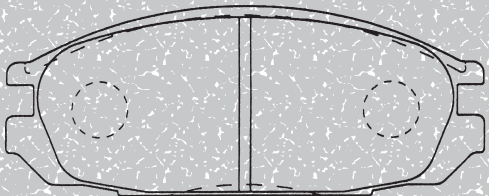

X: 128.0 Y: 50.5 Z: 19.0

MN-306M (リヤ)

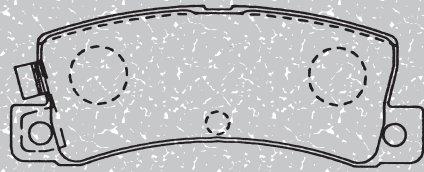

X: 107.8 Y: 35.0 Z: 15.5

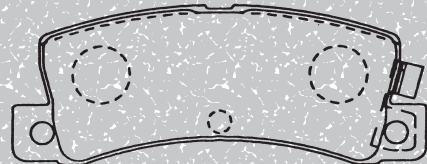

X: 107.8 Y: 35.0 Z: 15.5

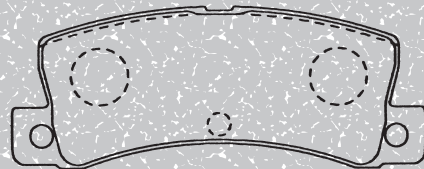

X: 107.8 Y: 35.0 Z: 15.5

MN-304

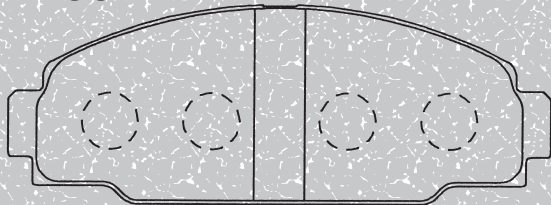

X: 144.4 Y: 52.5 Z: 15.5

MN-308M

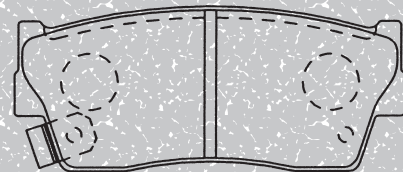

X: 103.5 Y: 41.0 Z: 15.0

MN-305

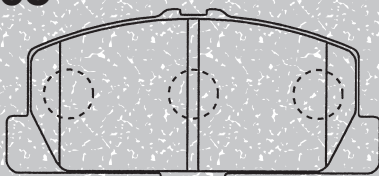

X: 98.7 Y: 43.5 Z: 15.0

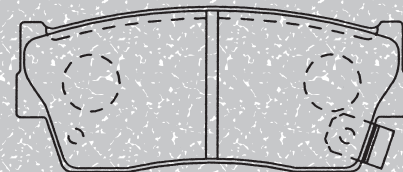

X: 103.5 Y: 41.0 Z: 15.0

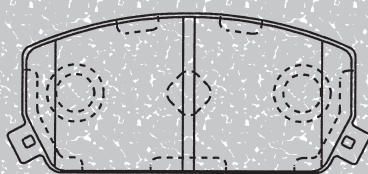

X: 95.7 Y: 42.0 Z: 15.7

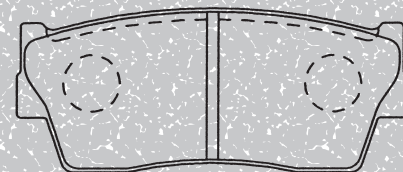

X: 103.5 Y: 41.0 Z: 15.0

BRAKE PADS

MN-309

販売中止

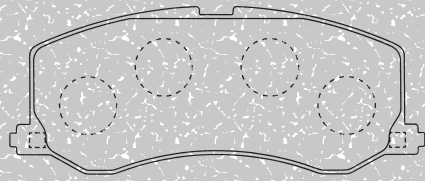

X: 109.4 Y: 37.5 Z: 14.0

MN-313M

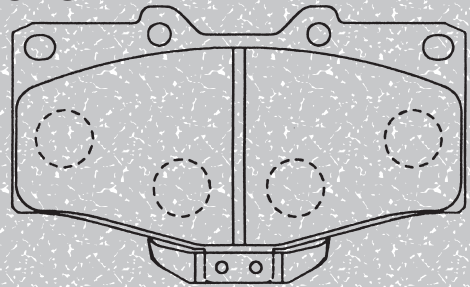

*X: 119.4
Y: 66.0
Z: 17.0*

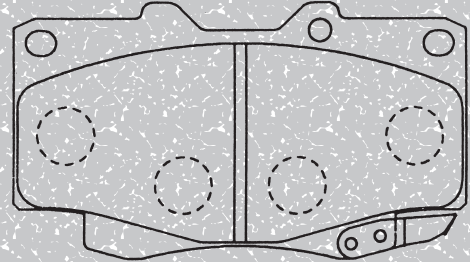

*X: 119.4
Y: 57.0
Z: 17.0*

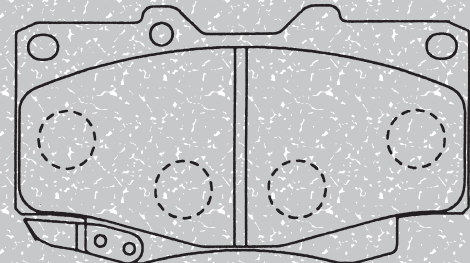

*X: 119.4
Y: 57.0
Z: 17.0*

MN-196Mと似ていますが、互換性はありません。

MN-312M

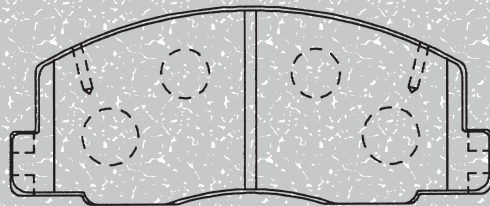

X: 128.4 Y: 49.0 Z: 15.5

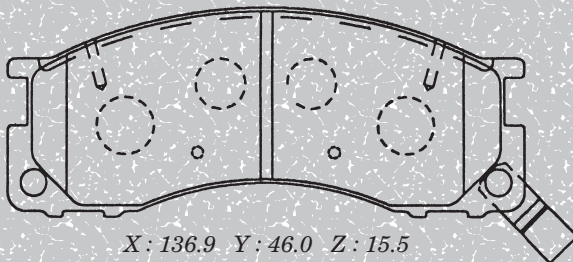

X: 136.9 Y: 46.0 Z: 15.5

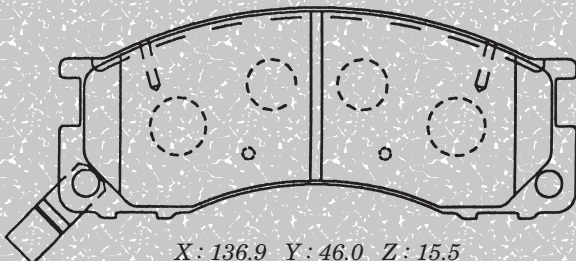

X: 136.9 Y: 46.0 Z: 15.5

MN-314M

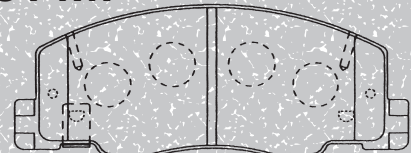

X: 128.4 Y: 49.0 Z: 15.5

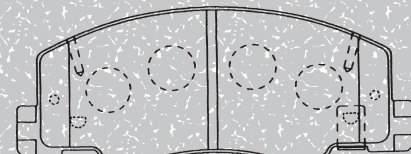

X: 128.4 Y: 49.0 Z: 15.5

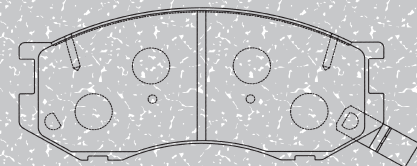

X: 126.8 Y: 49.0 Z: 15.5

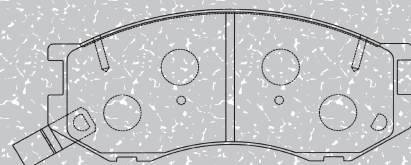

X: 126.8 Y: 49.0 Z: 15.5

BRAKE PADS

MN-315M

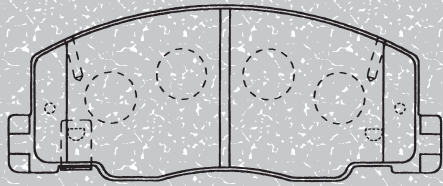

X: 128.4 Y: 49.0 Z: 15.5

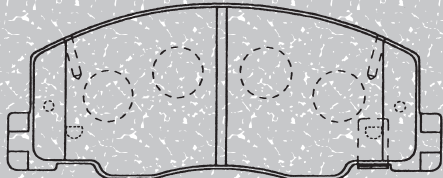

X: 128.4 Y: 49.0 Z: 15.5

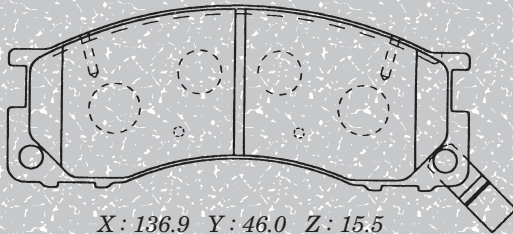

X: 136.9 Y: 46.0 Z: 15.5

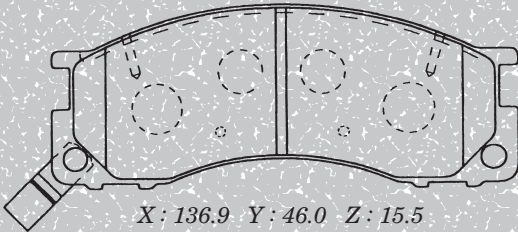

X: 136.9 Y: 46.0 Z: 15.5

MN-316 (リヤ)

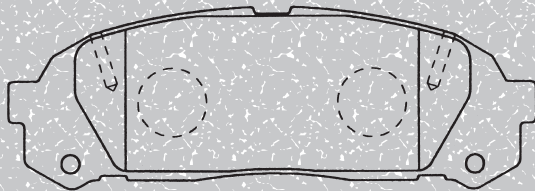

X: 116.0 Y: 35.0 Z: 17.5

MN-318

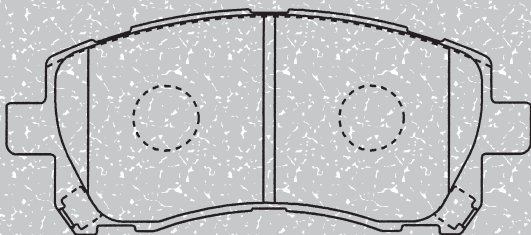

X: 137.7 Y: 51.5 Z: 17.0

MN-319

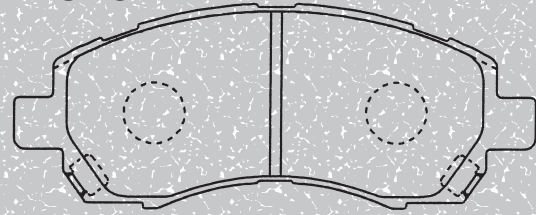

X: 137.8 Y: 45.6 Z: 16.5

MN-320

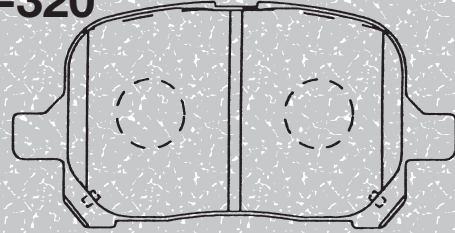

X: 117.0 Y: 54.5 Z: 17.0

MN-321

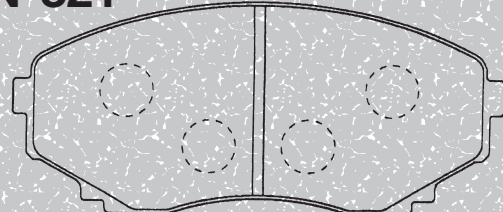

X: 139.0 Y: 56.0 Z: 16.0

MN-322M

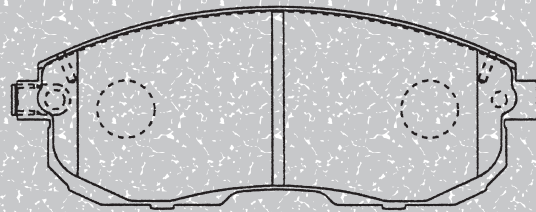

X: 137.0 Y: 48.0 Z: 17.0

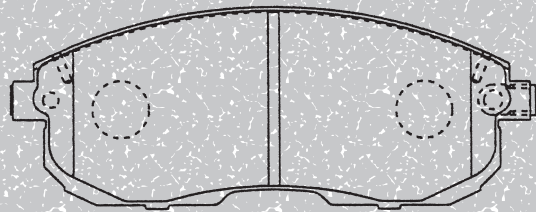

X: 137.0 Y: 48.0 Z: 17.0

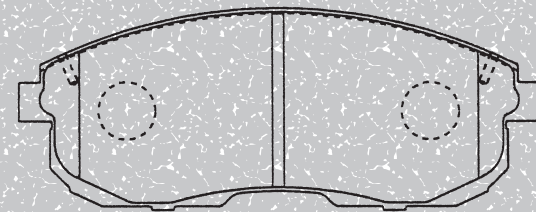

X: 137.0 Y: 48.0 Z: 17.0

BRAKE PADS

MN-323M

X: 91.7
Y: 57.5
Z: 14.5

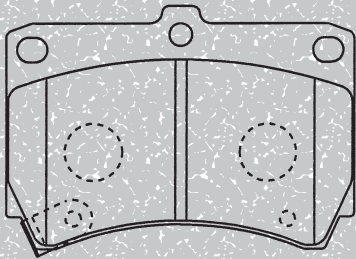

X: 91.7
Y: 57.5
Z: 14.5

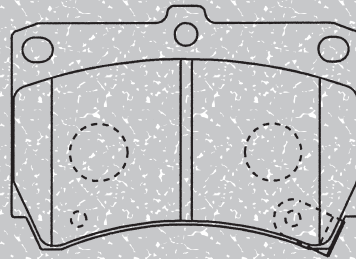

X: 91.7
Y: 57.5
Z: 14.5

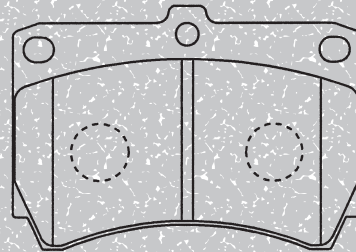

MN-325M

X: 183.3 Y: 49.0 Z: 22.0

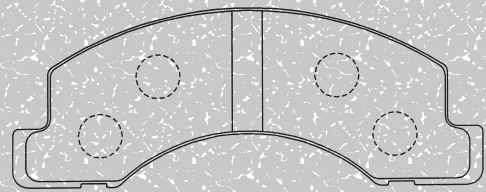

X: 238.5 Y: 49.0 Z: 22.0

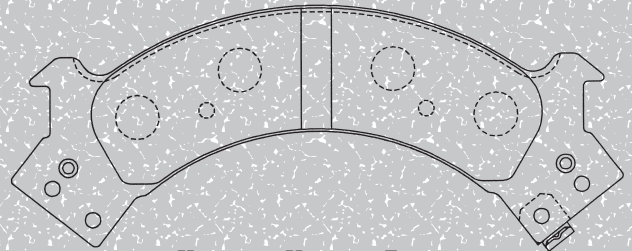

X: 238.5 Y: 49.0 Z: 22.0

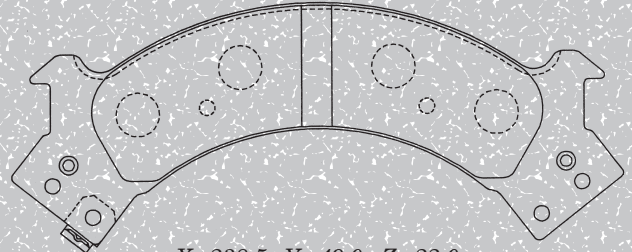

MN-324M 販売中止

X: 91.7
Y: 64.5
Z: 14.5

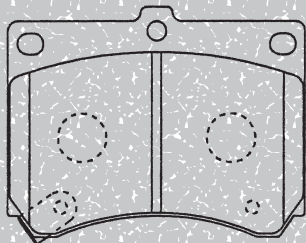

X: 91.7
Y: 64.5
Z: 14.5

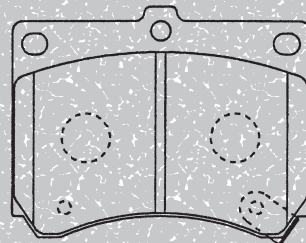

X: 91.7
Y: 64.5
Z: 14.5

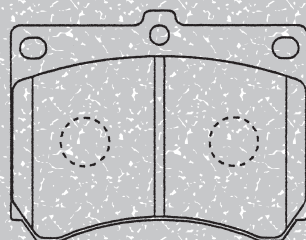

MN-326

X: 160.7 Y: 48.5 Z: 17.0

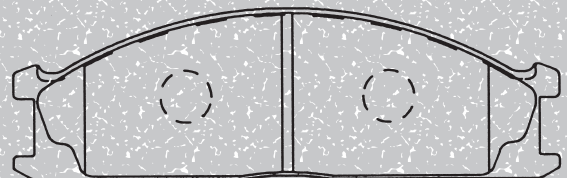

MN-327

X: 106.3 Y: 42.0 Z: 15.0

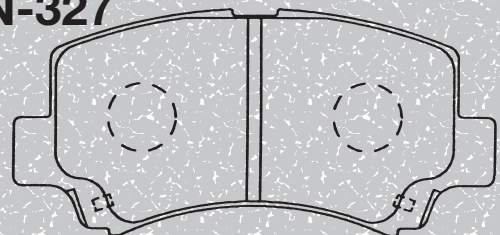

MN-328

X: 114.0 Y: 47.0 Z: 15.0

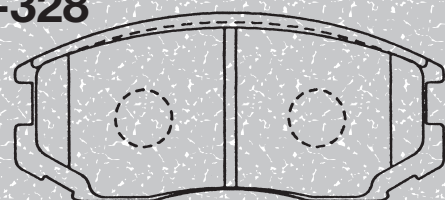

BRAKE PADS

MN-330M

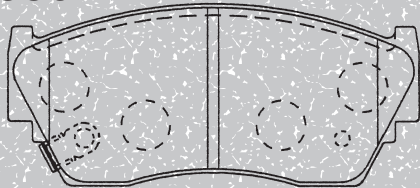

X: 108.6 Y: 44.5 Z: 15.5

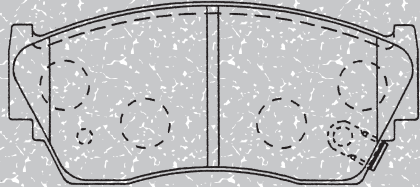

X: 108.6 Y: 44.5 Z: 15.5

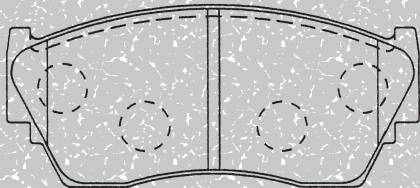

X: 108.6 Y: 44.5 Z: 15.5

MN-331M

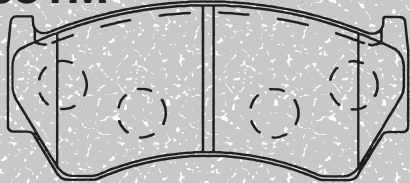

X: 108.6 Y: 41.5 Z: 15.5

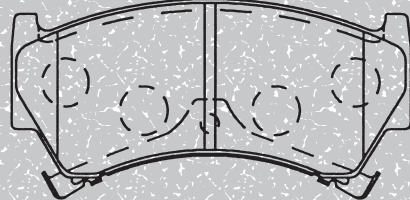

X: 108.6 Y: 41.5 Z: 15.5

MN-332M (リヤ)

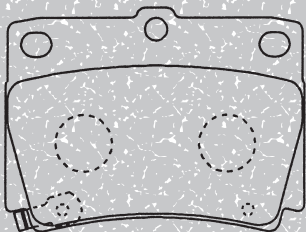

*X: 78.8
Y: 55.2
Z: 15.0*

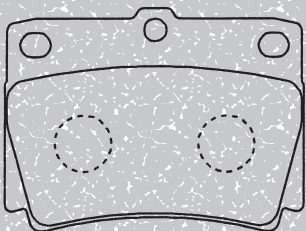

*X: 78.8
Y: 55.2
Z: 15.0*

MN-333 (リヤ)

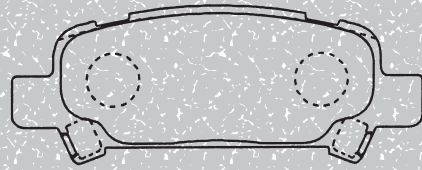

X: 108.3 Y: 37.2 Z: 13.5

MN-334

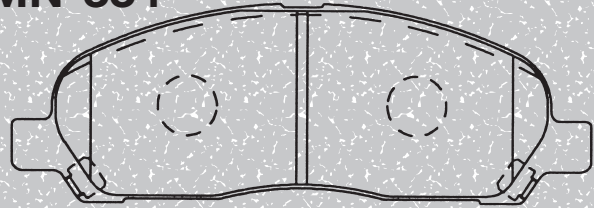

X: 156.8 Y: 48.5 Z: 15.5

MN-335M (リヤ)

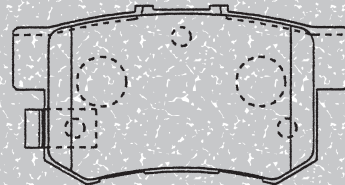

X: 88.7 Y: 42.5 Z: 14.5

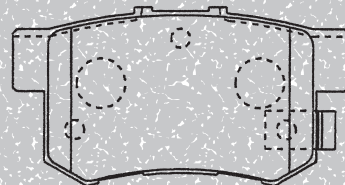

X: 88.7 Y: 42.5 Z: 14.5

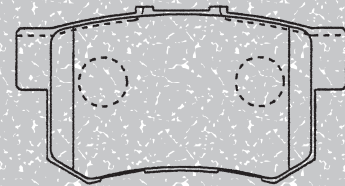

X: 88.7 Y: 42.5 Z: 14.5

MN-336

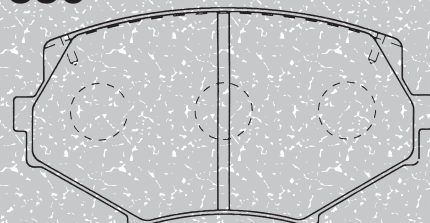

X: 110.0 Y: 54.5 Z: 13.0

BRAKE PADS

MN-337M

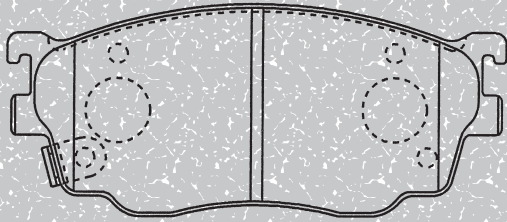

X: 131.5 Y: 53.0 Z: 16.0

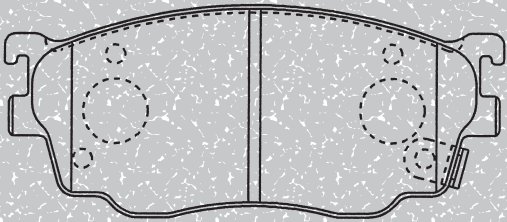

X: 131.5 Y: 53.0 Z: 16.0

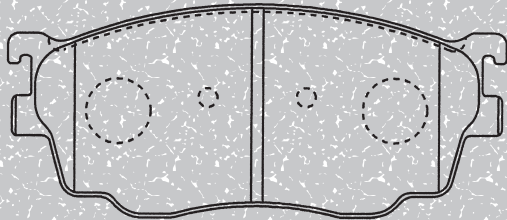

X: 131.5 Y: 53.0 Z: 15.0

MN-338M

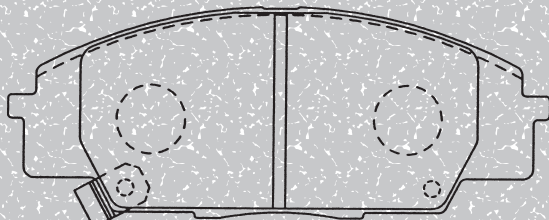

X: 135.0 Y: 50.5 Z: 17.0

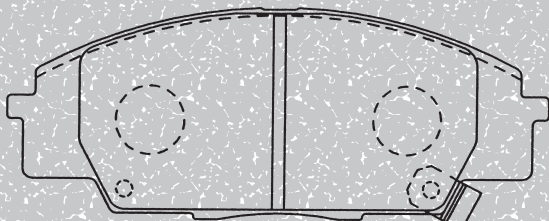

X: 135.0 Y: 50.5 Z: 17.0

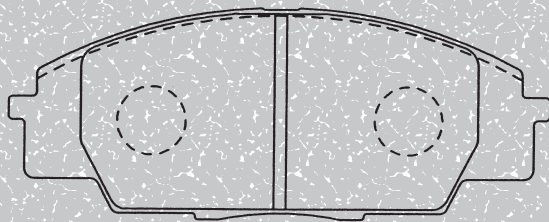

X: 135.0 Y: 50.5 Z: 17.0

MN-339

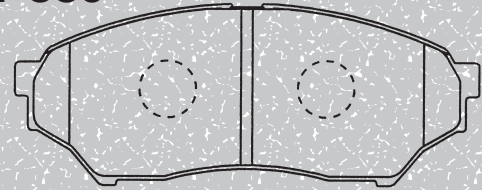

X: 123.0 Y: 42.5 Z: 15.5

MN-340

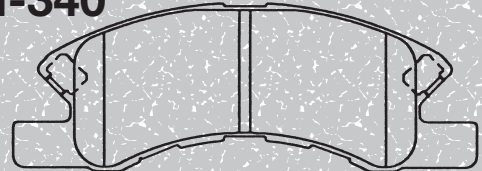

X: 122.2 Y: 34.0 Z: 15.0

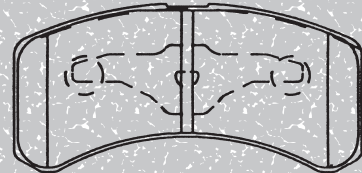

X: 92.0 Y: 34.0 Z: 15.0

MN-341

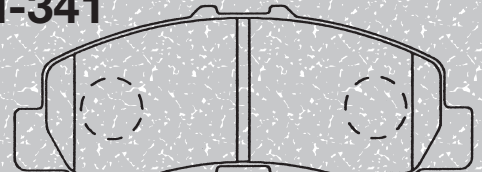

X: 112.4 Y: 37.0 Z: 13.5

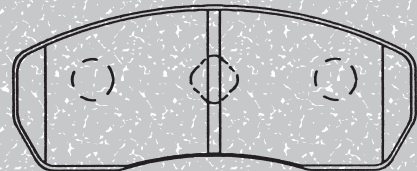

X: 99.0 Y: 36.5 Z: 13.5

MN-343

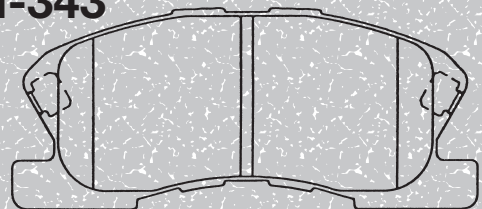

X: 115.5 Y: 41.5 Z: 15.5

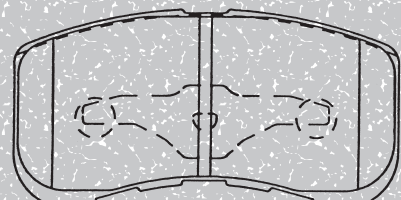

X: 95.0 Y: 41.5 Z: 15.5

BRAKE PADS

MN-345M

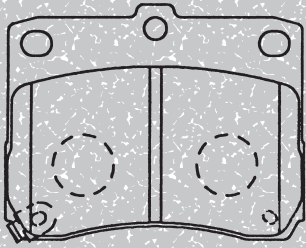

X: 78.8 Y: 58.5 Z: 14.5

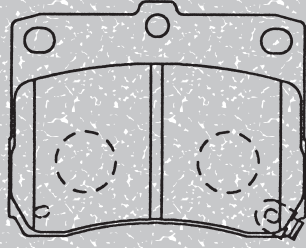

X: 78.8 Y: 58.5 Z: 14.5

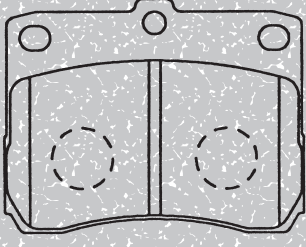

X: 78.8 Y: 58.5 Z: 14.5

MN-348M

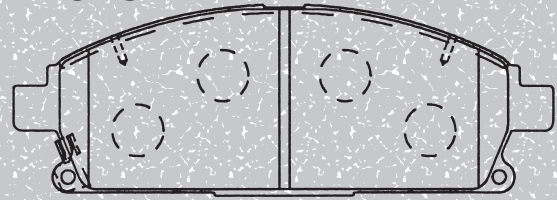

X: 158.8 Y: 55.0 Z: 16.5

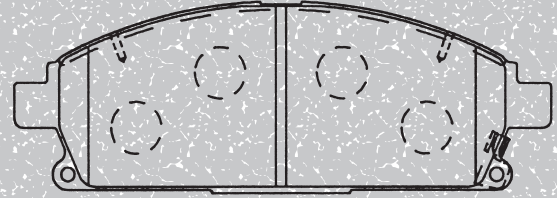

X: 158.8 Y: 55.0 Z: 16.5

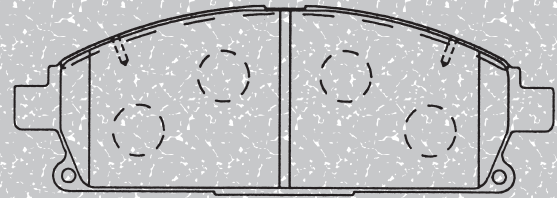

X: 158.8 Y: 55.0 Z: 16.5

MN-349

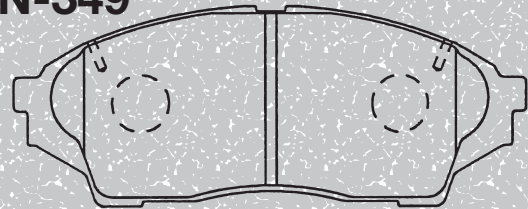

X: 137.0 Y: 47.5 Z: 17.0

MN-347M

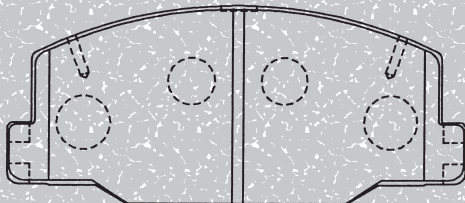

X: 128.4 Y: 55.0 Z: 15.5

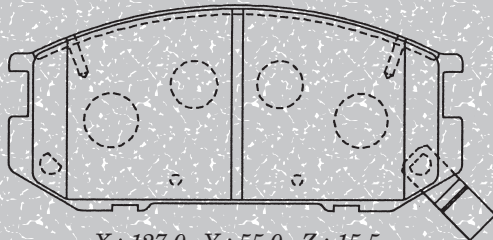

X: 127.0 Y: 55.0 Z: 15.5

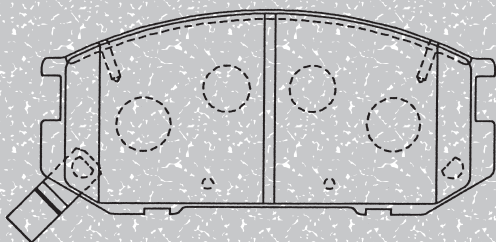

X: 127.0 Y: 55.0 Z: 15.5

MN-350M

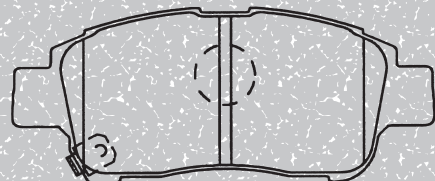

X: 112.6 Y: 41.5 Z: 16.0

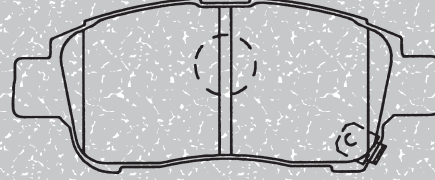

X: 112.6 Y: 41.5 Z: 16.0

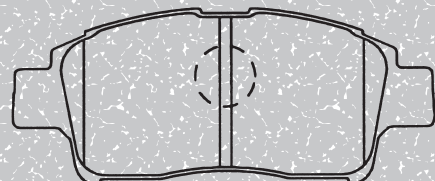

X: 112.6 Y: 41.5 Z: 16.0

BRAKE PADS

MN-351M

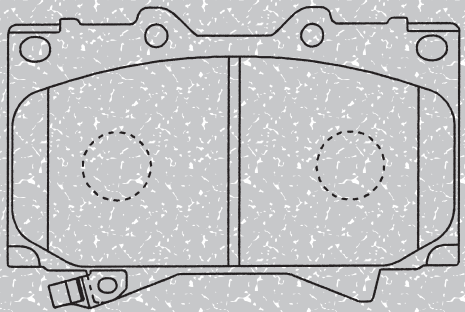

X: 119.4 Y: 63.0 Z: 17.5

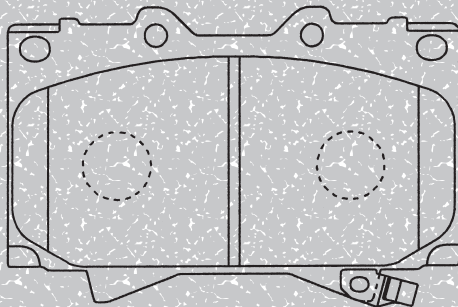

X: 119.4 Y: 63.0 Z: 17.5

MN-355M

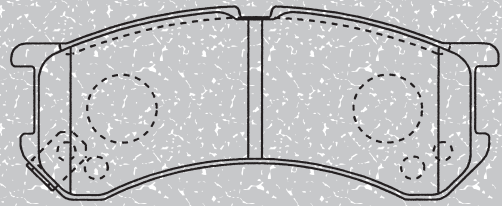

X: 106.0 Y: 32.0 Z: 14.5

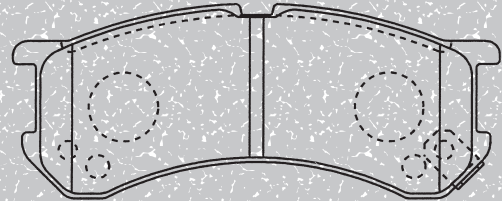

X: 106.0 Y: 32.0 Z: 14.5

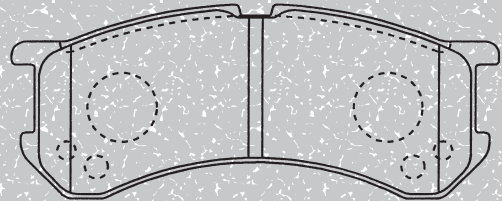

X: 106.0 Y: 32.0 Z: 14.5

MN-352 (リヤ)

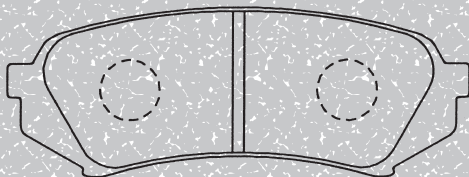

X: 123.0 Y: 39.5 Z: 17.0

MN-356

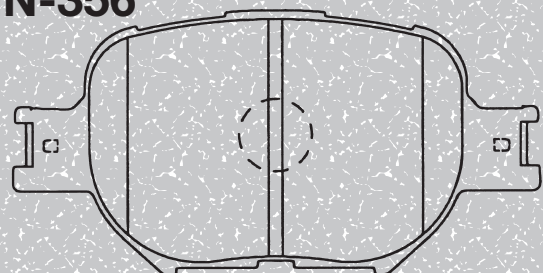

X: 117.7 Y: 55.5 Z: 17.0

MN-353M (リヤ)

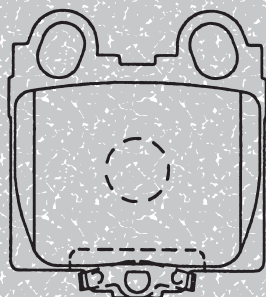

X: 57.4 Y: 51.5 Z: 15.0

MN-357 (リヤ)

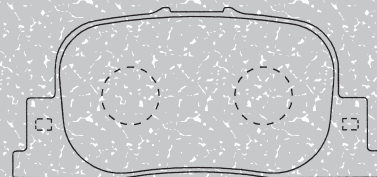

X: 83.0 Y: 36.0 Z: 14.5

MN-354

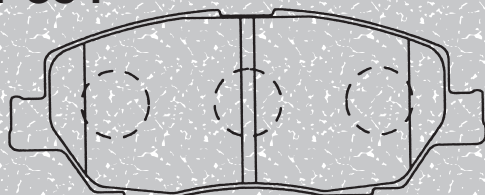

X: 106.3 Y: 38.5 Z: 14.5

MN-358

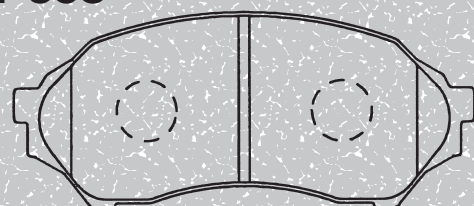

X: 123.0 Y: 46.0 Z: 15.0

BRAKE PADS

MN-359M

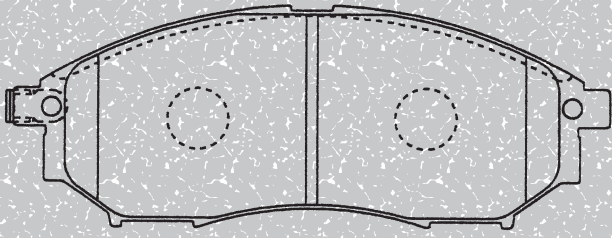

X: 157.0 Y: 52.0 Z: 16.0

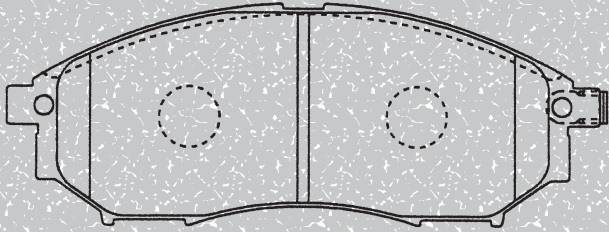

X: 157.0 Y: 52.0 Z: 16.0

MN-362M

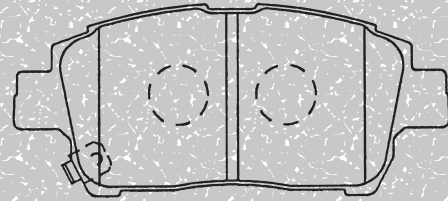

X: 116.6 Y: 47.0 Z: 16.0

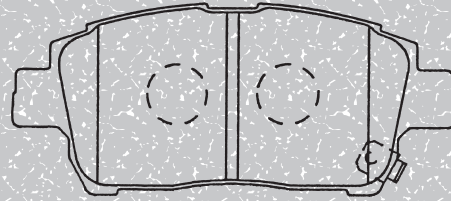

X: 116.6 Y: 47.0 Z: 16.0

MN-360M

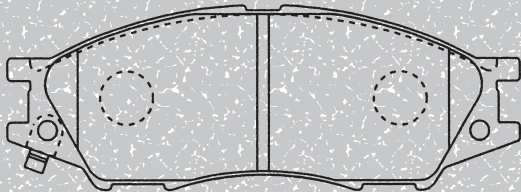

X: 135.0 Y: 43.0 Z: 15.5

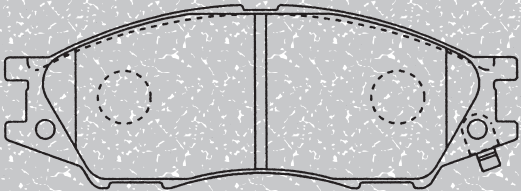

X: 135.0 Y: 43.0 Z: 15.5

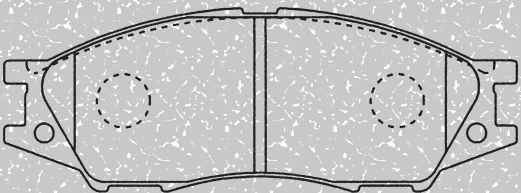

X: 135.0 Y: 43.0 Z: 15.5

MN-363

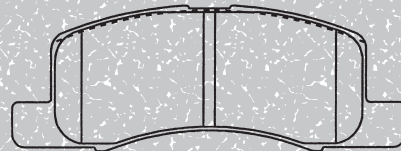

X: 103.5 Y: 32.5 Z: 14.5

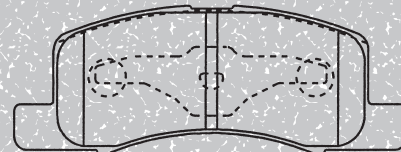

X: 103.5 Y: 32.5 Z: 14.5

MN-361

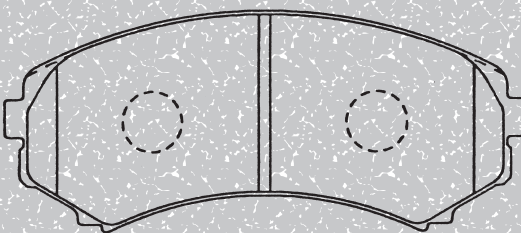

X: 139.0 Y: 49.0 Z: 15.0

BRAKE PADS

MN-364M

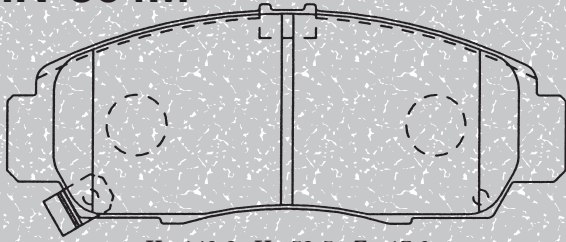

X: 148.8 Y: 52.5 Z: 17.0

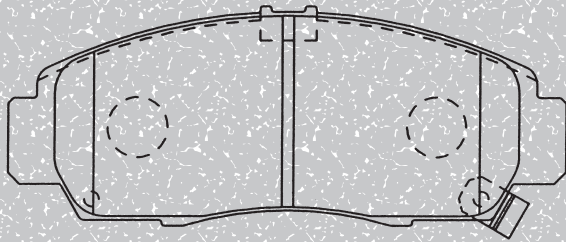

X: 148.8 Y: 52.5 Z: 17.0

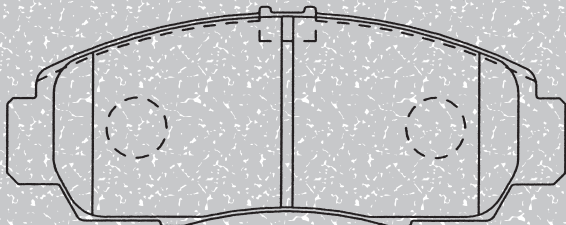

X: 148.8 Y: 52.5 Z: 17.0

MN-368M (リヤ)

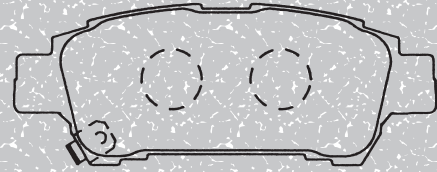

X: 112.6 Y: 38.5 Z: 16.0

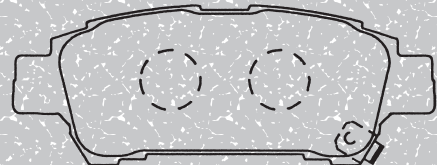

X: 112.6 Y: 38.5 Z: 16.0

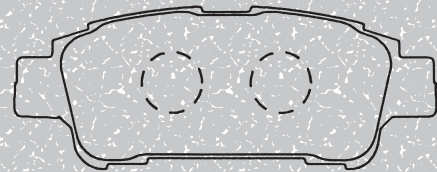

X: 112.6 Y: 38.5 Z: 16.0

MN-365

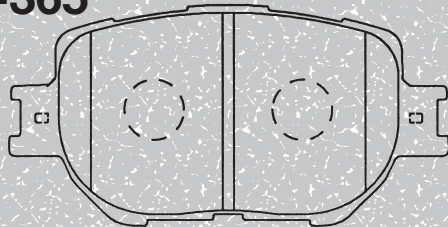

X: 117.7 Y: 55.5 Z: 17.0

MN-369M

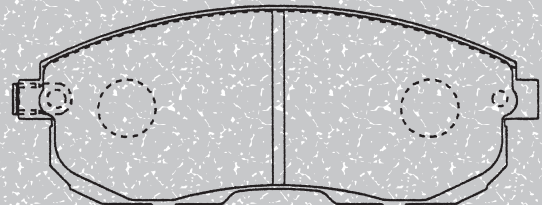

X: 137.0 Y: 48.0 Z: 17.0

MN-366

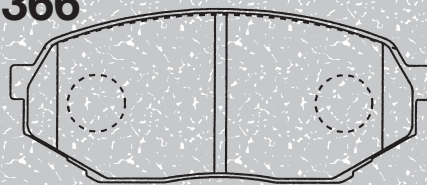

X: 110.0 Y: 44.5 Z: 14.5

センサー同梱

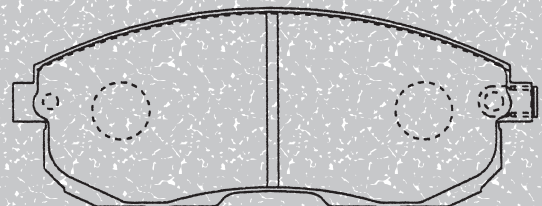

X: 137.0 Y: 48.0 Z: 17.0

MN-367

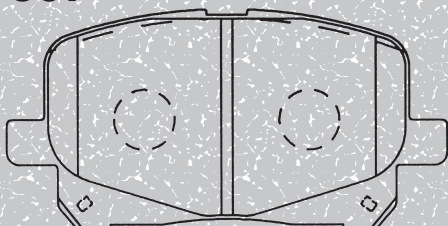

X: 117.0 Y: 54.5 Z: 16.5

MN-370

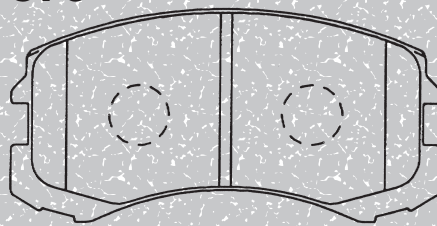

X: 114.0 Y: 48.0 Z: 15.0

BRAKE PADS

MN-371M

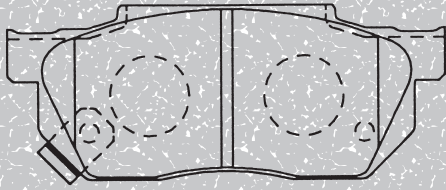

X: 116.0 Y: 43.0 Z: 14.0

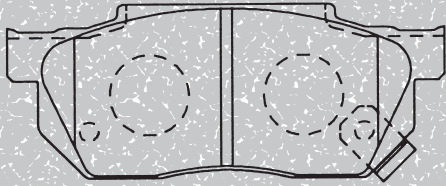

X: 116.0 Y: 43.0 Z: 14.0

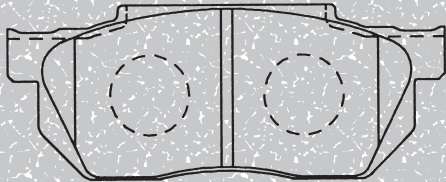

X: 116.0 Y: 43.0 Z: 14.0

MN-373

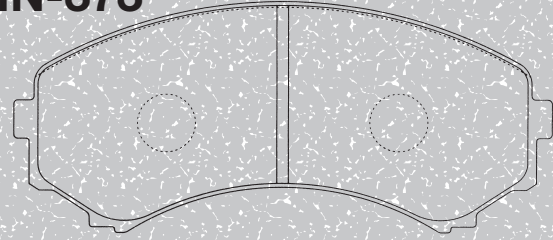

X: 139.0 Y: 47.0 Z: 16.0

MN-374 販売中止

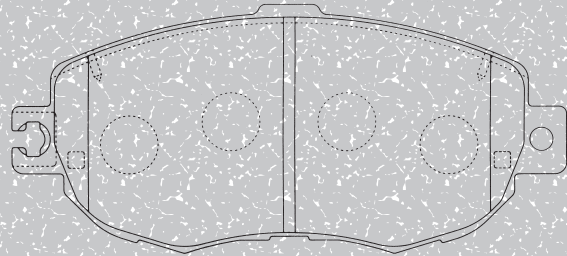

X: 144.0 Y: 59.5 Z: 17.0

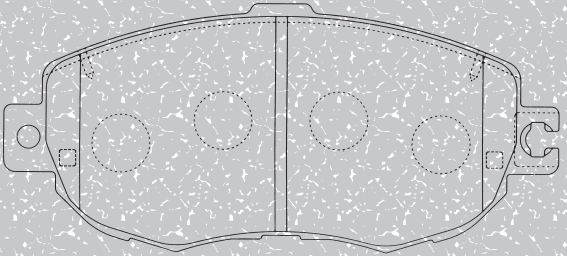

X: 144.0 Y: 59.5 Z: 17.0

MN-372M

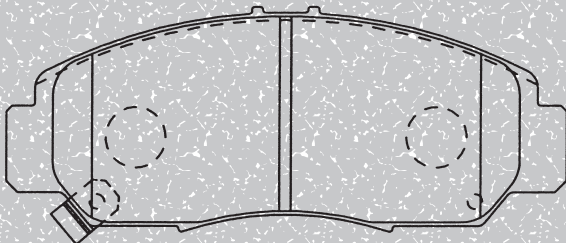

X: 148.8 Y: 53.5 Z: 15.5

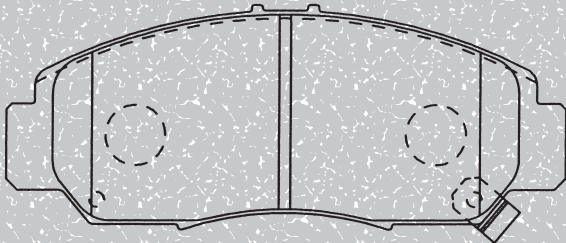

X: 148.8 Y: 53.5 Z: 15.5

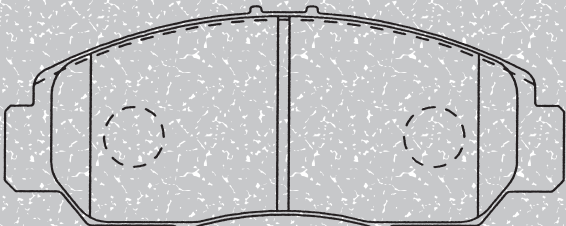

X: 148.8 Y: 53.5 Z: 15.5

MN-375

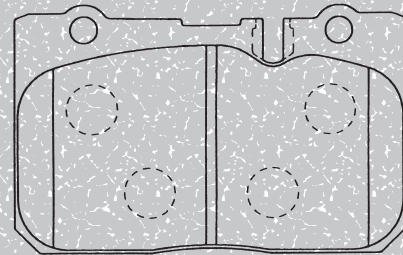

X: 115.5 Y: 67.0 Z: 17.0

MN-376 (リヤ)

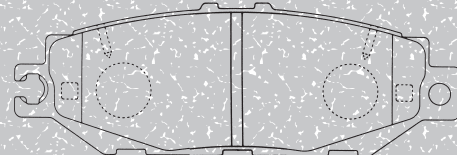

X: 121.9 Y: 38.0 Z: 15.5

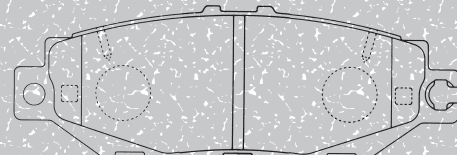

X: 121.9 Y: 38.0 Z: 15.5

BRAKE PADS

MN-377 (フロント&リヤ)

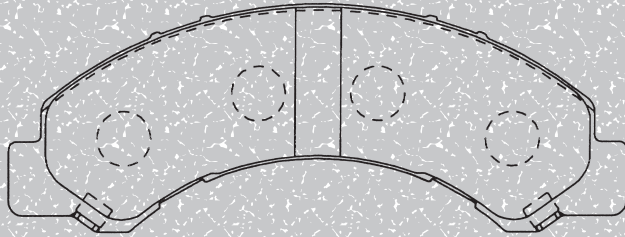

X: 206.3 Y: 51.0 Z: 20.0

MN-380M

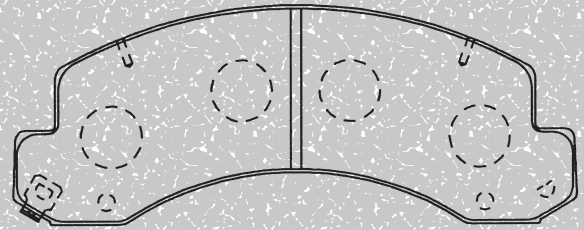

X: 166.6 Y: 49.0 Z: 20.0

MN-378M

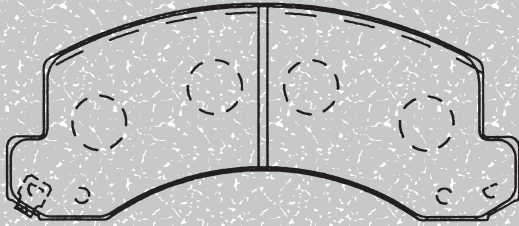

X: 170.9 Y: 55.5 Z: 20.0

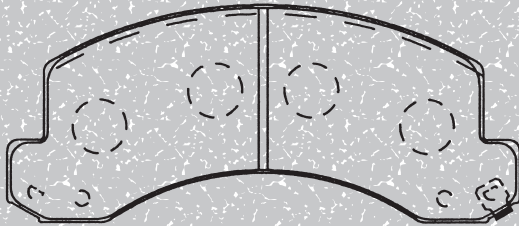

X: 170.9 Y: 55.5 Z: 20.0

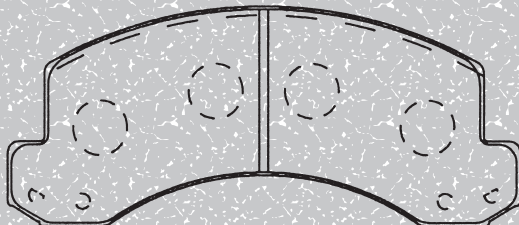

X: 170.9 Y: 55.5 Z: 20.0

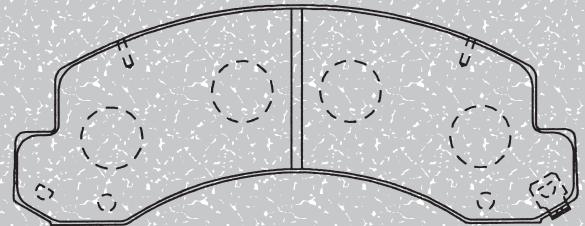

X: 166.6 Y: 49.0 Z: 20.0

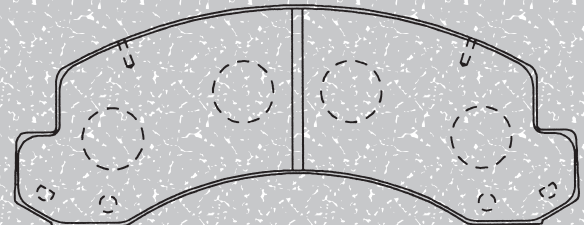

X: 166.6 Y: 49.0 Z: 20.0

MN-381M

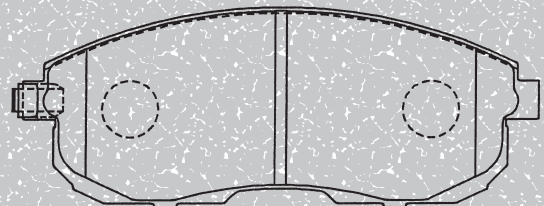

X: 137.0 Y: 48.0 Z: 15.5

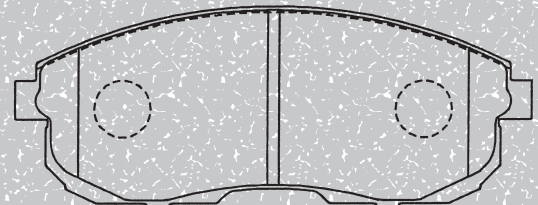

X: 137.0 Y: 48.0 Z: 15.5

センサー同梱

MN-379

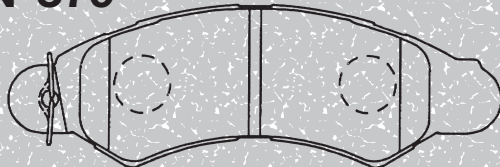

X: 131.1 Y: 34.5 Z: 14.5

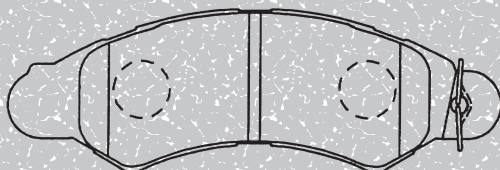

X: 131.1 Y: 34.5 Z: 14.5

BRAKE PADS

MN-382M

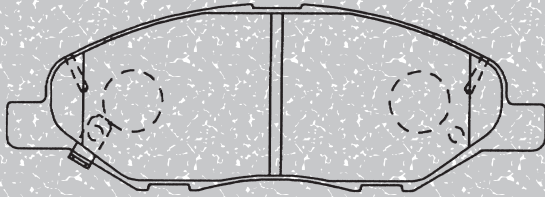

X: 144.3 Y: 44.5 Z: 14.0

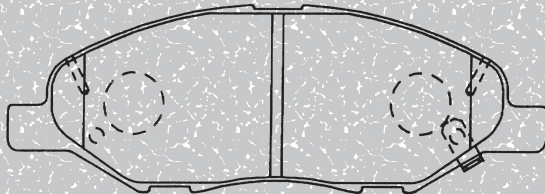

X: 144.3 Y: 44.5 Z: 14.0

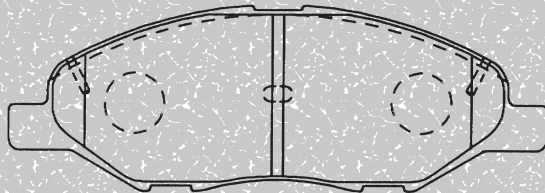

X: 144.3 Y: 44.5 Z: 14.0

MN-386M

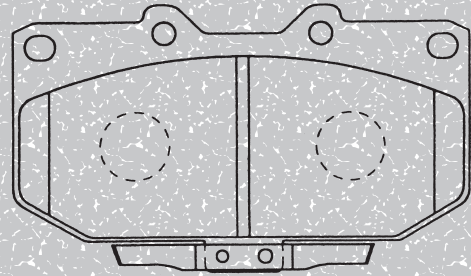

X: 119.2 Y: 62.5 Z: 14.5

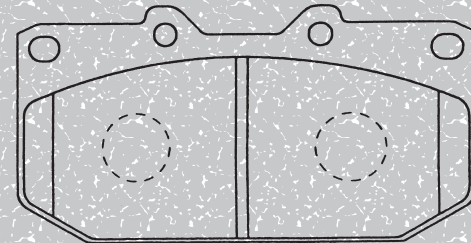

X: 119.2 Y: 54.5 Z: 14.5

MN-415Mと似ていますが、互換性はありません。

MN-384

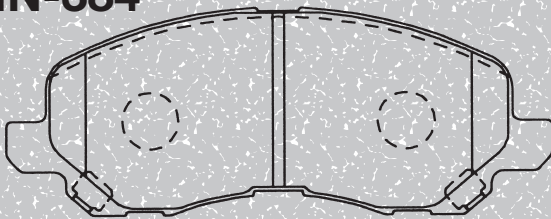

X: 145.0 Y: 47.5 Z: 15.5

MN-387M

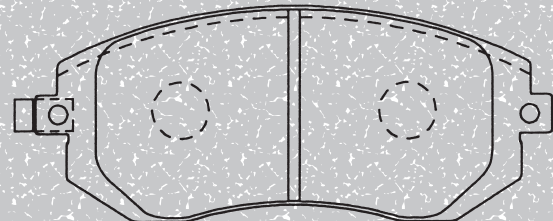

X: 137.0 Y: 52.5 Z: 16.5

MN-385

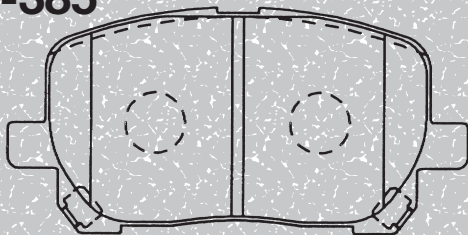

X: 123.1 Y: 54.5 Z: 16.5

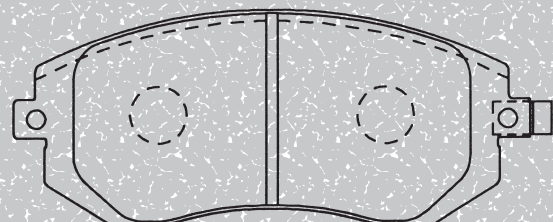

X: 137.0 Y: 52.5 Z: 16.5

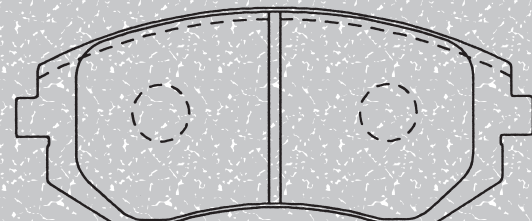

X: 137.0 Y: 52.5 Z: 16.5

BRAKE PADS

MN-388M

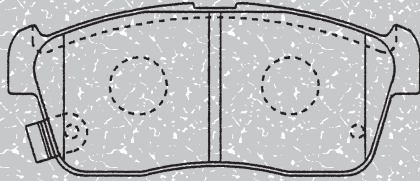

X: 108.6 Y: 41.5 Z: 14.5

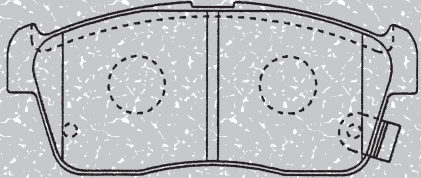

X: 108.6 Y: 41.5 Z: 14.5

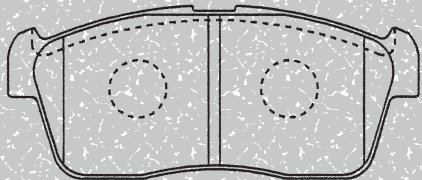

X: 108.6 Y: 41.5 Z: 14.5

MN-390M

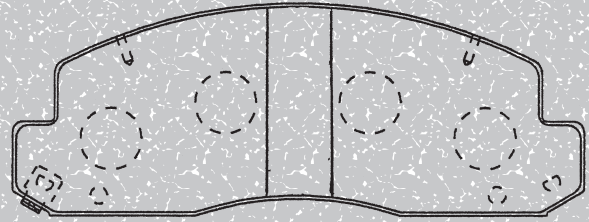

X: 166.6 Y: 57.0 Z: 20.0

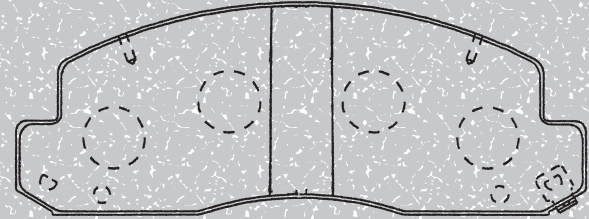

X: 166.6 Y: 57.0 Z: 20.0

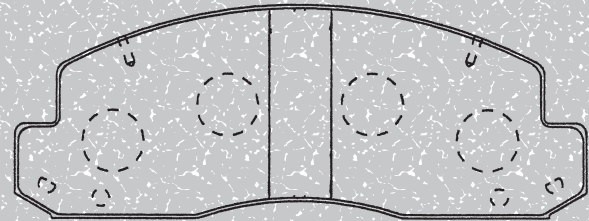

X: 166.6 Y: 57.0 Z: 20.0

MN-389M (リヤ)

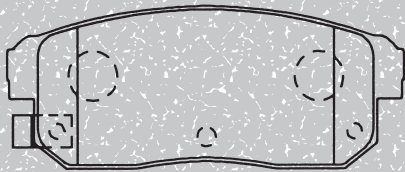

X: 105.3 Y: 41.0 Z: 15.5

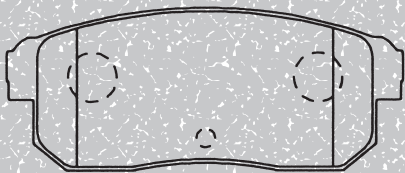

X: 105.3 Y: 41.0 Z: 15.5

MN-391M (リヤ)

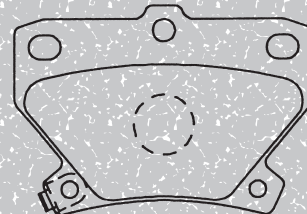

X: 78.8 Y: 51.5 Z: 13.5

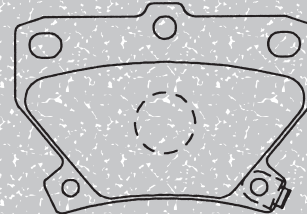

X: 78.8 Y: 51.5 Z: 13.5

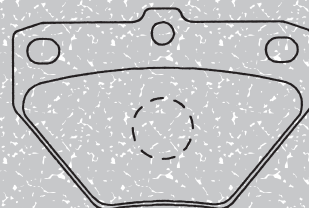

X: 78.8 Y: 51.5 Z: 13.5

BRAKE PADS

MN-392

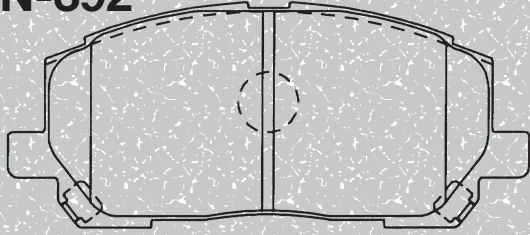

X: 138.8 Y: 54.5 Z: 18.5

MN-396M

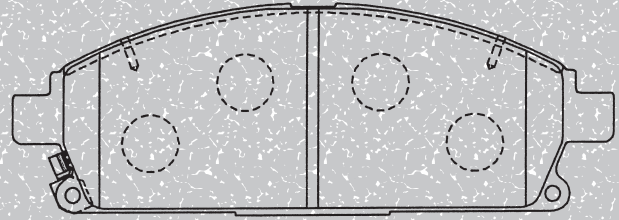

X: 158.8 Y: 55.0 Z: 15.0

MN-393 (リヤ)

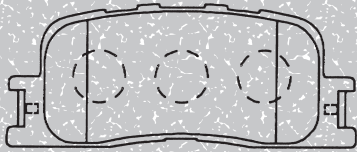

X: 93.0 Y: 34.7 Z: 15.5

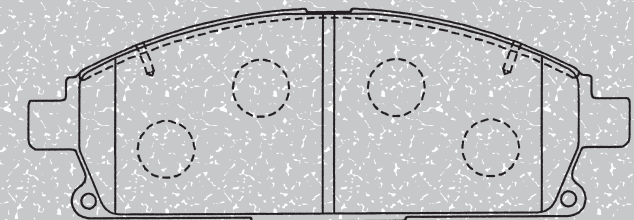

X: 158.8 Y: 55.0 Z: 15.0

MN-394

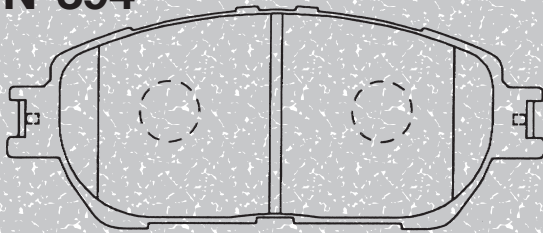

X: 143.7 Y: 54.5 Z: 16.0

MN-397

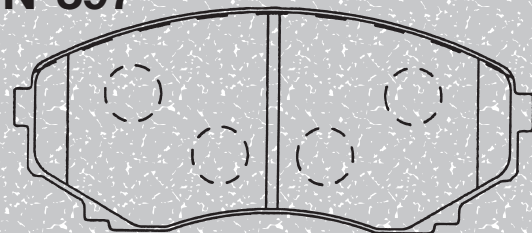

X: 139.0 Y: 54.0 Z: 15.5

MN-395M

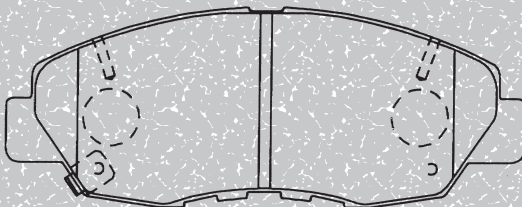

X: 137.8 Y: 47.5 Z: 16.5

MN-398M

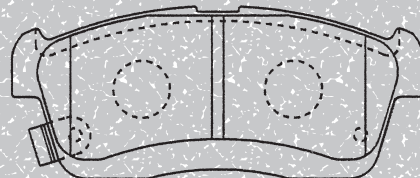

X: 108.6 Y: 41.5 Z: 15.0

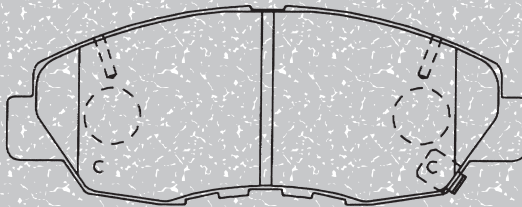

X: 137.8 Y: 47.5 Z: 16.5

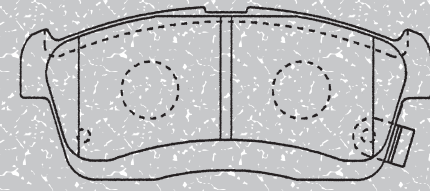

X: 108.6 Y: 41.5 Z: 15.0

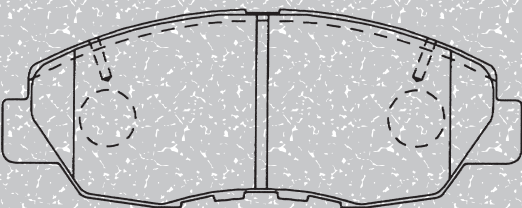

X: 137.8 Y: 47.5 Z: 16.5

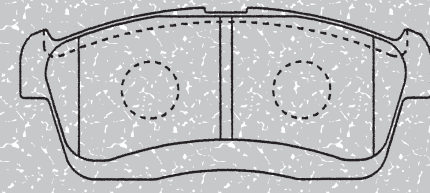

X: 108.6 Y: 41.5 Z: 15.0

BRAKE PADS

MN-399M

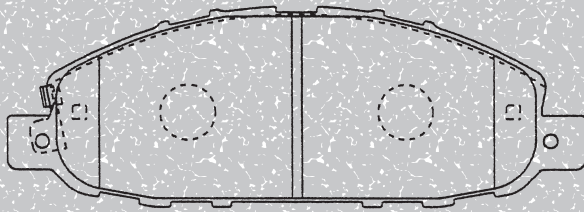

X: 168.8 Y: 55.2 Z: 17.0

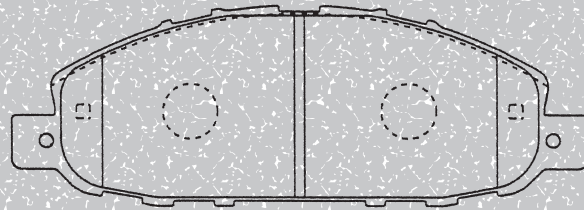

X: 168.8 Y: 55.2 Z: 17.0

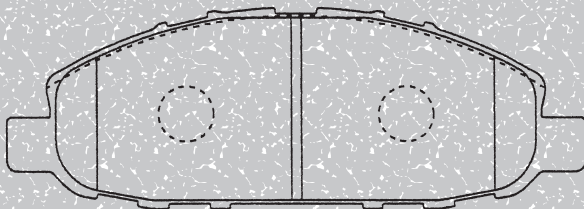

X: 168.8 Y: 55.2 Z: 17.0

MN-402M

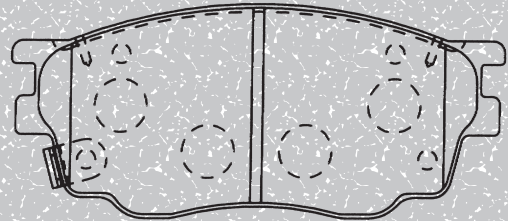

X: 131.5 Y: 53.0 Z: 15.5

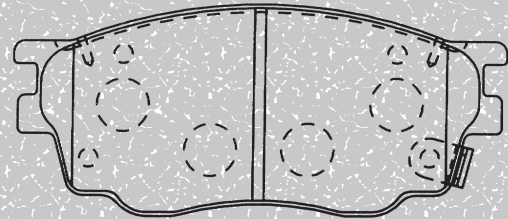

X: 131.5 Y: 53.0 Z: 15.5

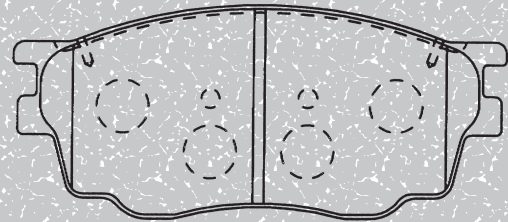

X: 131.5 Y: 53.0 Z: 15.5

MN-400

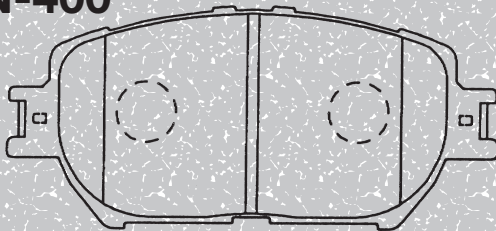

X: 131.7 Y: 54.5 Z: 17.0

MN-403M

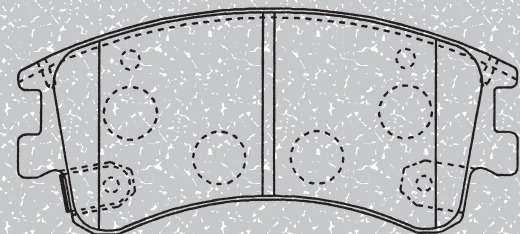

X: 132.2 Y: 50.5 Z: 17.0

MN-401

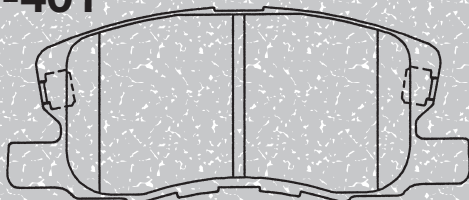

X: 122.2 Y: 46.5 Z: 15.0

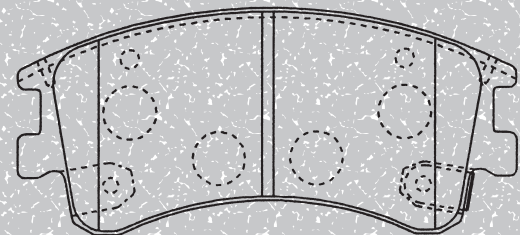

X: 132.2 Y: 50.5 Z: 17.0

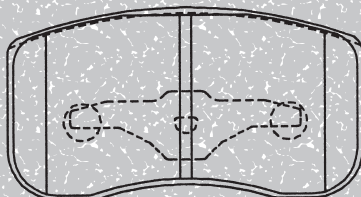

X: 94.0 Y: 46.5 Z: 15.0

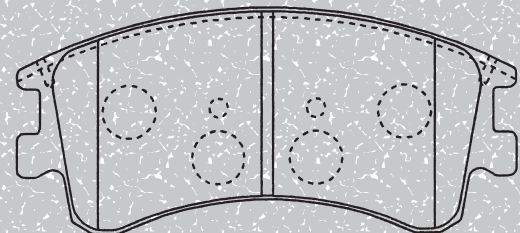

X: 132.2 Y: 50.5 Z: 17.0

BRAKE PADS

MN-404M (リヤ)

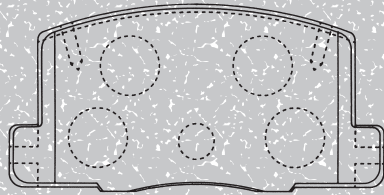

X: 98.7 Y: 45.5 Z: 16.0

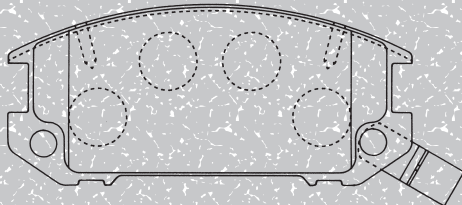

X: 106.7 Y: 44.6 Z: 15.5

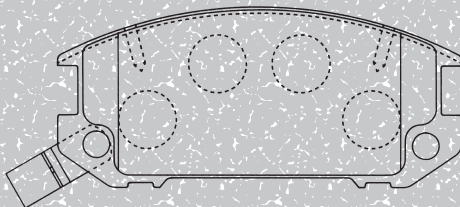

X: 106.7 Y: 44.6 Z: 15.5

MN-407M

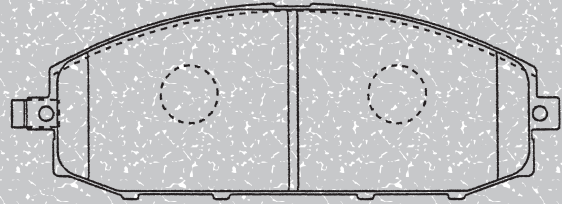

X: 166.0 Y: 58.5 Z: 16.5

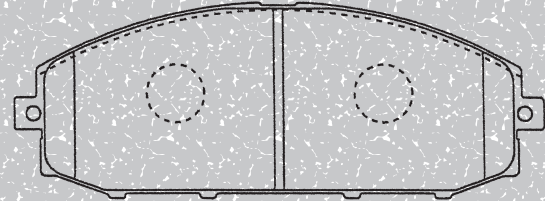

X: 166.0 Y: 58.5 Z: 16.5

MN-408

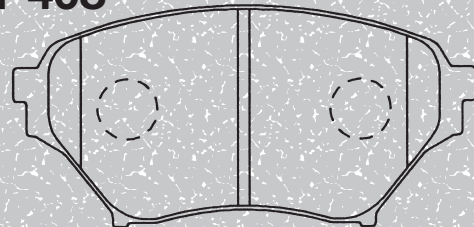

X: 123.0 Y: 54.0 Z: 15.0

MN-405

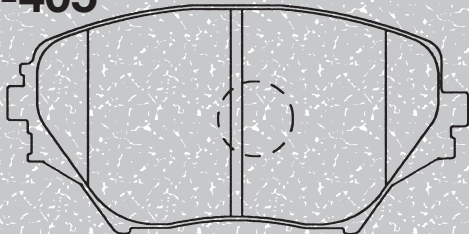

X: 123.0 Y: 57.0 Z: 17.0

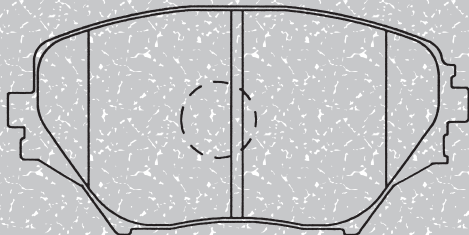

X: 123.0 Y: 57.0 Z: 17.0

MN-409M (リヤ)



X: 102.0 Y: 38.0 Z: 12.0



X: 102.0 Y: 38.0 Z: 12.0

MN-406

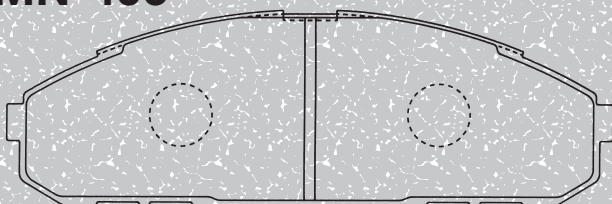

X: 170.0 Y: 53.0 Z: 18.0

MN-410

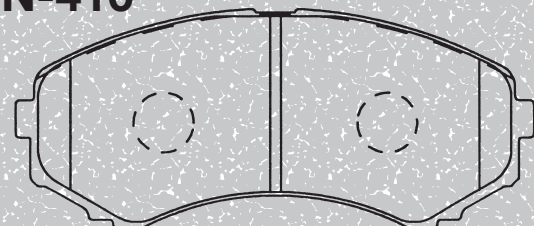

X: 139.0 Y: 49.0 Z: 15.5

BRAKE PADS

MN-411 (リヤ)

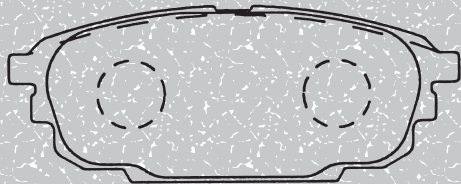

X: 100.5 Y: 38.0 Z: 13.0

MN-414 (リヤ)

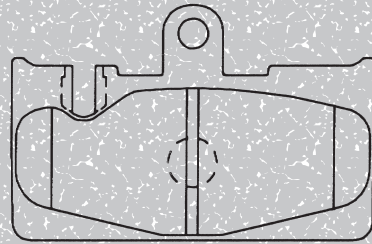

X: 96.2 Y: 62.0 Z: 14.5

MN-412M

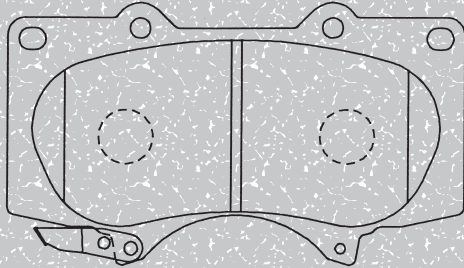

X: 134.6 Y: 55.0 Z: 16.5

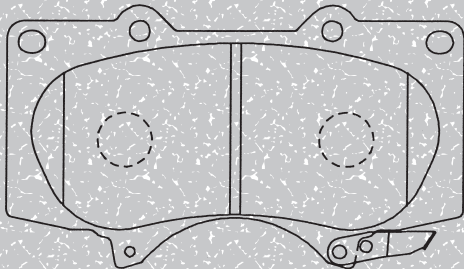

X: 134.6 Y: 55.0 Z: 16.5

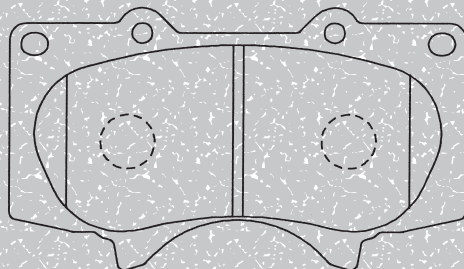

X: 134.6 Y: 55.0 Z: 16.5

MN-415M

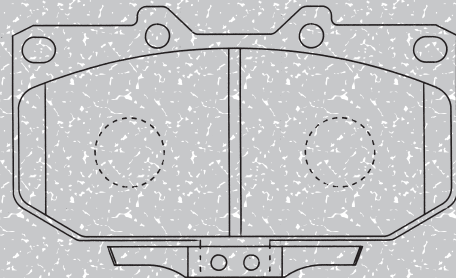

X: 119.2 Y: 62.5 Z: 14.5

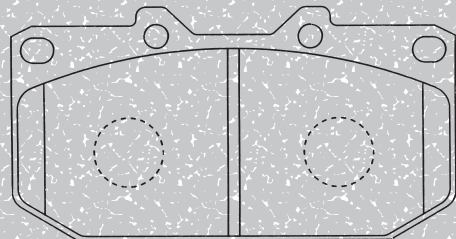

X: 119.2 Y: 54.5 Z: 14.5

MN-386Mと似ていますが、互換性はありません。

MN-413

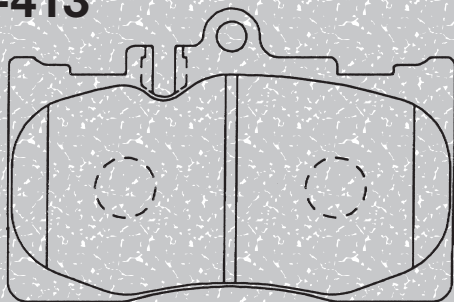

X: 118.6 Y: 73.5 Z: 15.5

BRAKE PADS

MN-416M

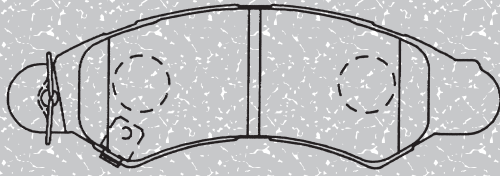

X: 131.1 Y: 34.5 Z: 14.5

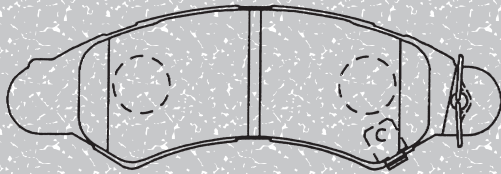

X: 131.1 Y: 34.5 Z: 14.5

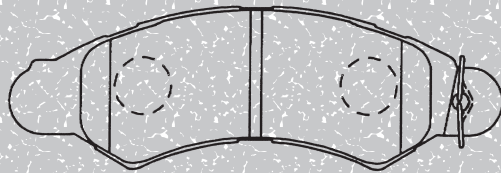

X: 131.1 Y: 34.5 Z: 14.5

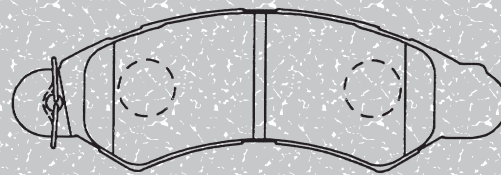

X: 131.1 Y: 34.5 Z: 14.5

MN-417

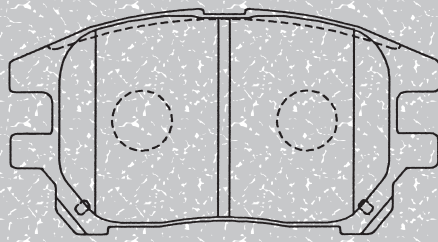

X: 114.7 Y: 54.5 Z: 16.5

MN-418

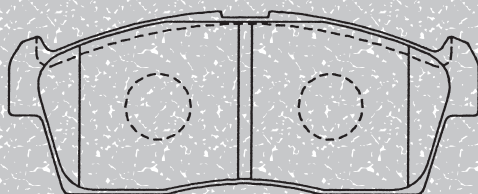

X: 108.6 Y: 38.0 Z: 14.5

MN-419

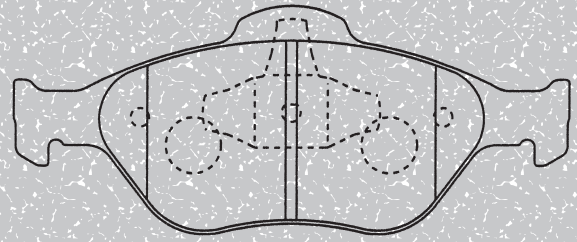

X: 150.0 Y: 58.3 Z: 17.5

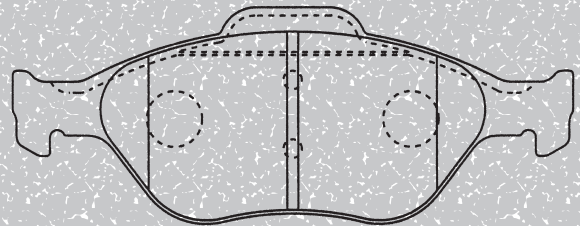

X: 151.3 Y: 55.5 Z: 17.5

MN-420 (リヤ)

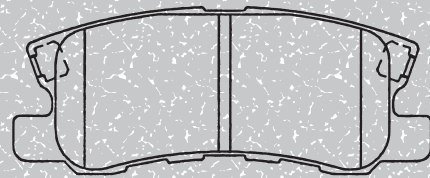

X: 111.5 Y: 39.0 Z: 15.0

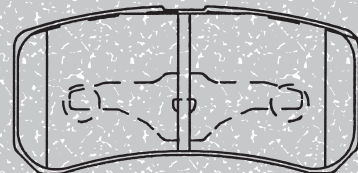

X: 91.0 Y: 39.0 Z: 15.0

MN-421

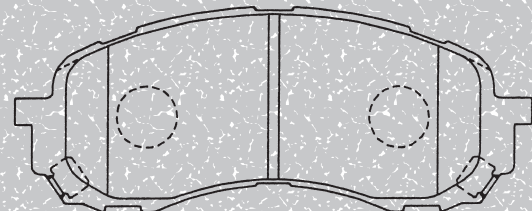

X: 137.0 Y: 45.5 Z: 16.5

BRAKE PADS

MN-422 (リヤ)

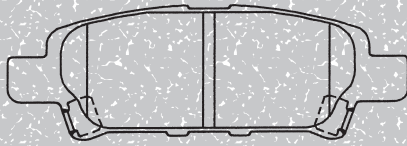

X: 106.0 Y: 32.5 Z: 15.0

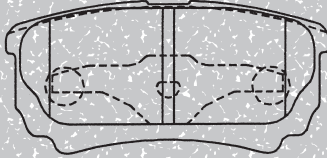

X: 85.5 Y: 35.5 Z: 15.5

MN-425

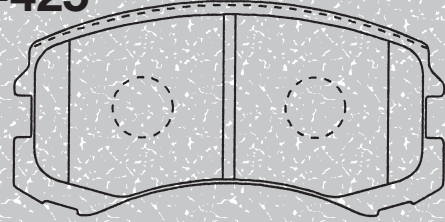

X: 114.0 Y: 48.0 Z: 15.0

MN-426

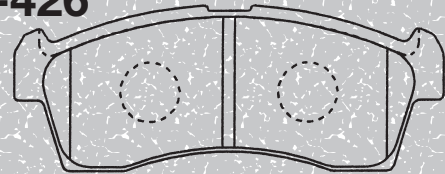

X: 108.6 Y: 35.5 Z: 14.5

MN-423M

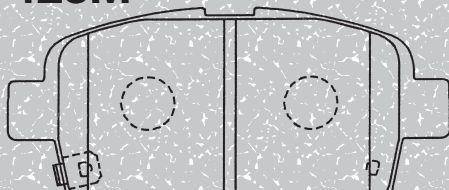

X: 116.7 Y: 47.8 Z: 15.0

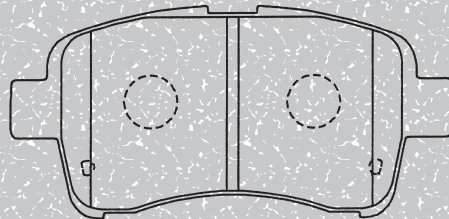

X: 116.7 Y: 47.8 Z: 15.0

MN-427

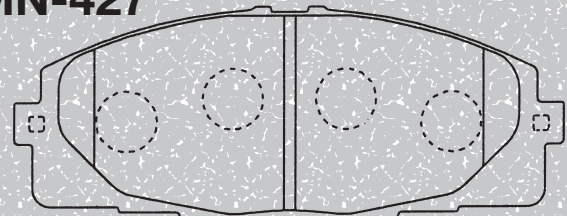

X: 145.5 Y: 54.5 Z: 15.5

MN-424M

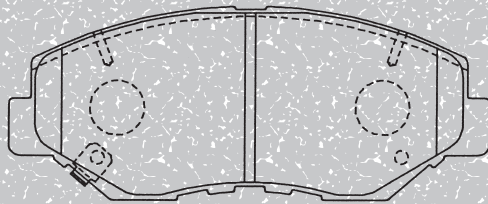

X: 141.8 Y: 51.8 Z: 16.5

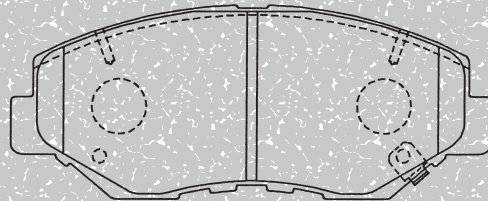

X: 141.8 Y: 51.8 Z: 16.5

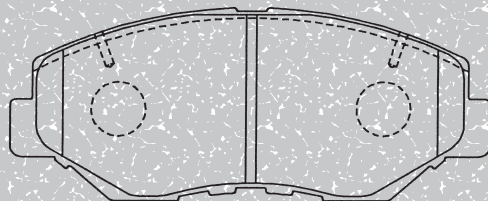

X: 141.8 Y: 51.8 Z: 16.5

MN-428M

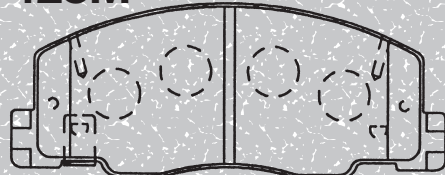

X: 128.4 Y: 49.0 Z: 15.5

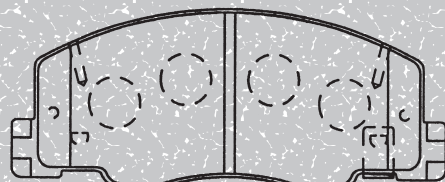

X: 128.4 Y: 49.0 Z: 15.5

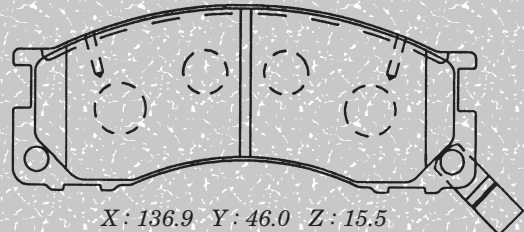

X: 136.9 Y: 46.0 Z: 15.5

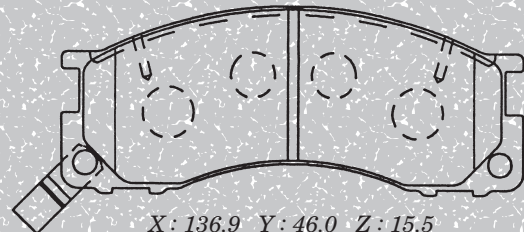

X: 136.9 Y: 46.0 Z: 15.5

BRAKE PADS

MN-429M (リヤ)

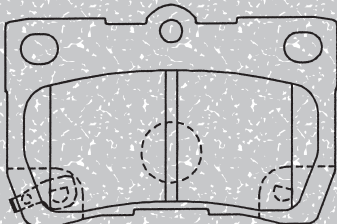

X: 88.1 Y: 54.0 Z: 15.0

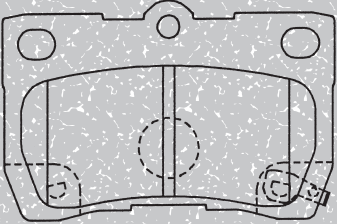

X: 88.1 Y: 54.0 Z: 15.0

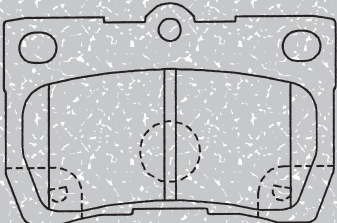

X: 88.1 Y: 54.0 Z: 15.0

MN-431

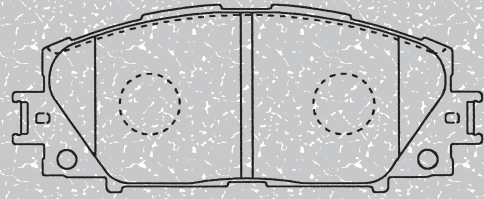

X: 123.5 Y: 45.7 Z: 17.0

MN-432M

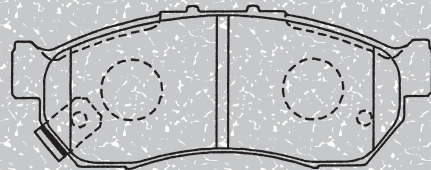

X: 111.0 Y: 37.0 Z: 14.5

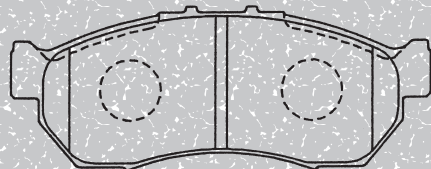

X: 111.0 Y: 37.0 Z: 14.5

MN-430M (リヤ)

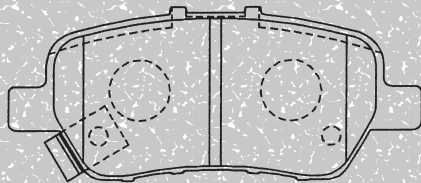

X: 108.9 Y: 41.5 Z: 14.5

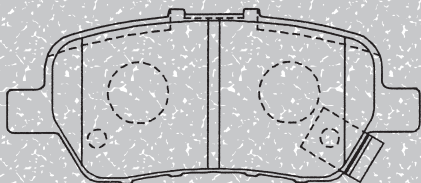

X: 108.9 Y: 41.5 Z: 14.5

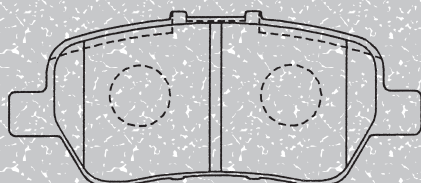

X: 108.9 Y: 41.5 Z: 14.5

MN-433

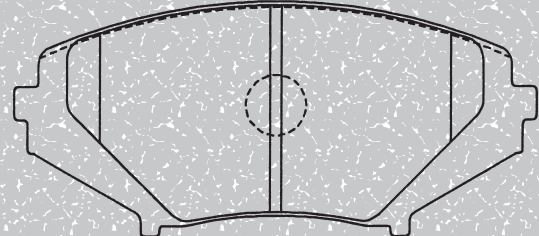

X: 138.0 Y: 56.5 Z: 16.0

MN-434 (フロント&リヤ)

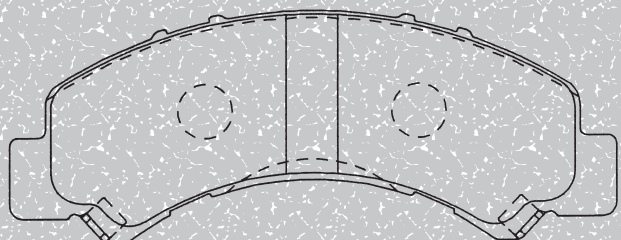

X: 178.3 Y: 49.5 Z: 21.0

BRAKE PADS

MN-435M

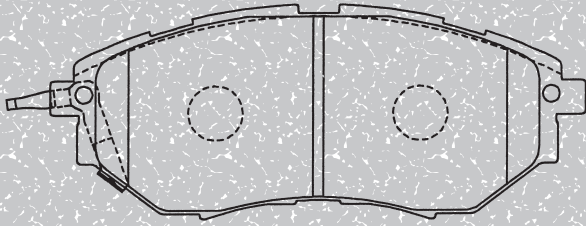

X: 157.0 Y: 55.0 Z: 16.5

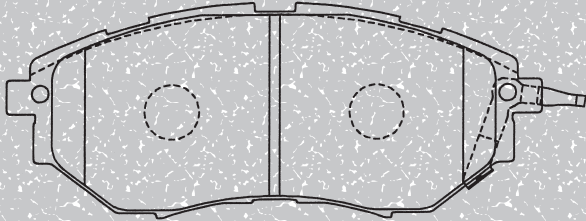

X: 157.0 Y: 55.0 Z: 16.5

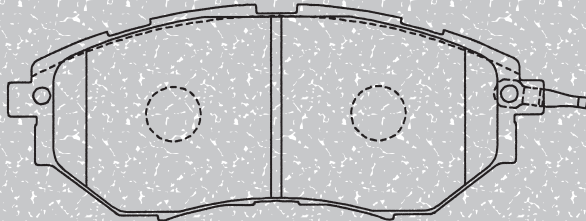

X: 157.0 Y: 55.0 Z: 16.5

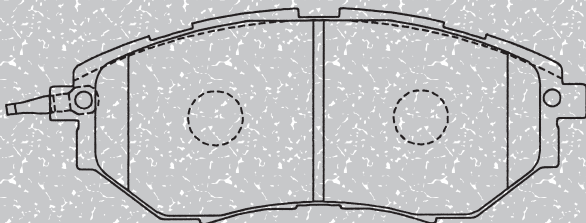

X: 157.0 Y: 55.0 Z: 16.5

MN-436M

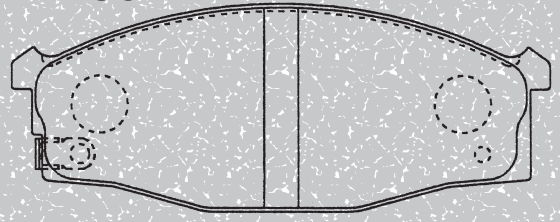

X: 142.0 Y: 54.5 Z: 18.0

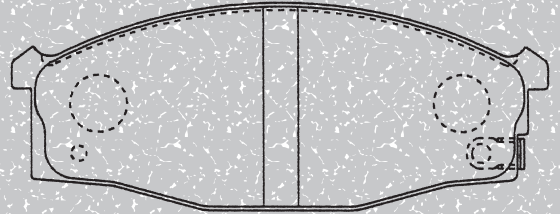

X: 142.0 Y: 54.5 Z: 18.0

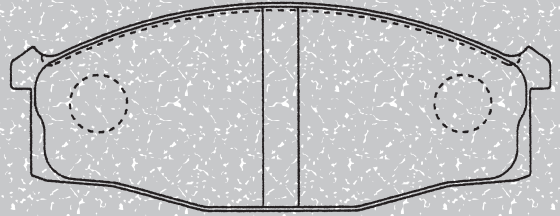

X: 142.0 Y: 54.5 Z: 18.0

MN-437M

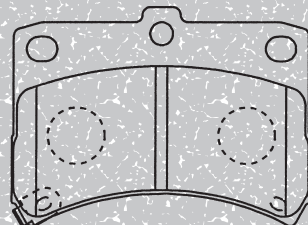

X: 78.8 Y: 49.5 Z: 14.5

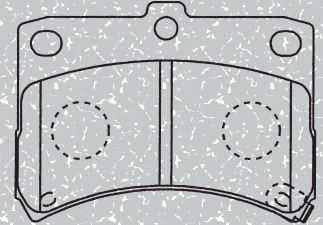

X: 78.8 Y: 49.5 Z: 14.5

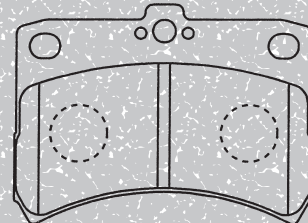

X: 78.8 Y: 49.5 Z: 14.5

[補足]

本アイテムは装着可能シムが2仕様あります

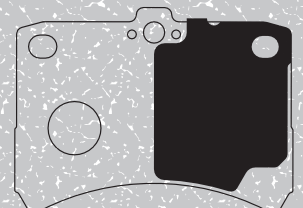
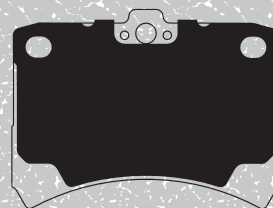

BRAKE PADS

MN-438

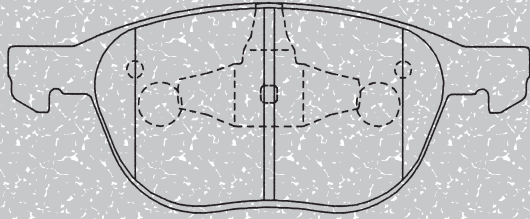

X: 155.3 Y: 60.5 Z: 17.0

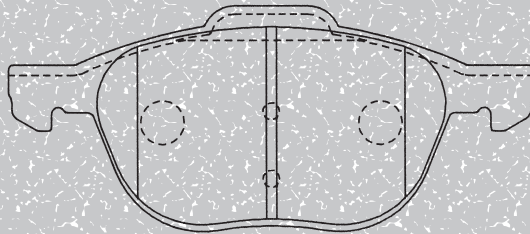

X: 156.5 Y: 65.3 Z: 17.0

MN-441M

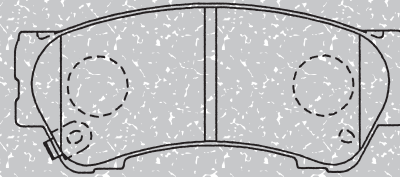

X: 103.8 Y: 37.5 Z: 13.5

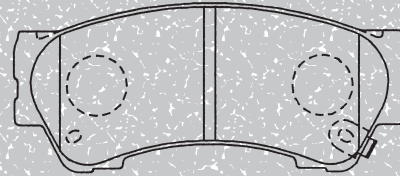

X: 103.8 Y: 37.5 Z: 13.5

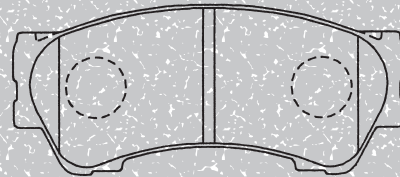

X: 103.8 Y: 37.5 Z: 13.5

MN-439(リヤ)

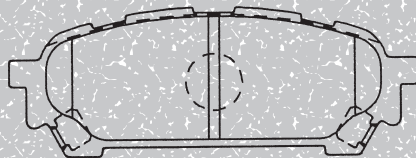

X: 108.5 Y: 35.5 Z: 13.5

MN-442

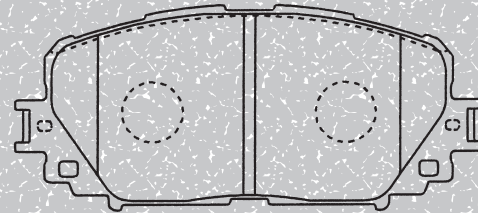

X: 123.5 Y: 50.0 Z: 17.0

MN-440M (リヤ)

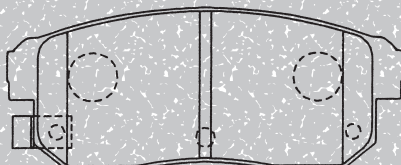

X: 105.3 Y: 41.0 Z: 14.0

MN-443M (リヤ)

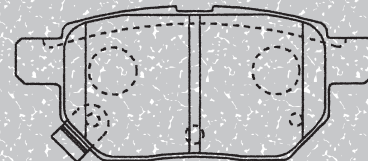

X: 98.6 Y: 40.0 Z: 14.5

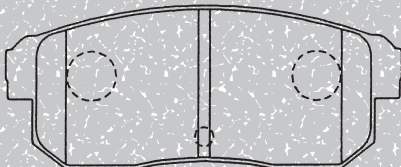

X: 105.3 Y: 41.0 Z: 14.0

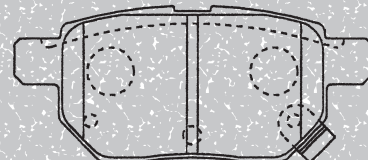

X: 98.6 Y: 40.0 Z: 14.5

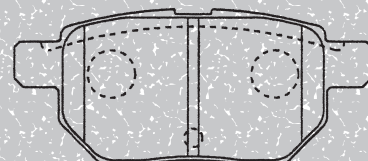

X: 98.6 Y: 40.0 Z: 14.5

BRAKE PADS

MN-444

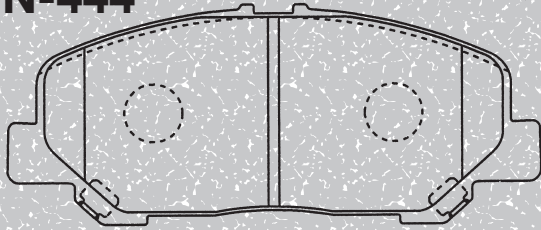

X: 147.8 Y: 54.5 Z: 17.5

MN-447

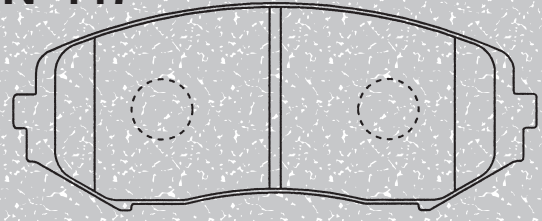

X: 138.0 Y: 50.0 Z: 16.0

MN-445M (リヤ)

シム付き

MN-448M

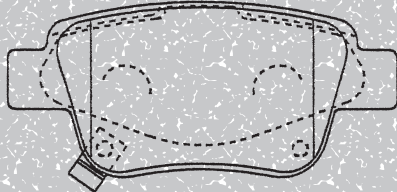

X: 102.0 Y: 44.0 Z: 15.0

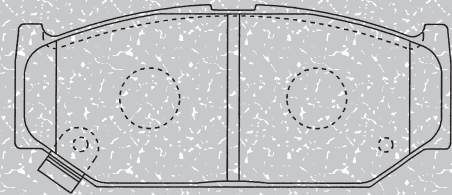

X: 108.6 Y: 44.0 Z: 14.5

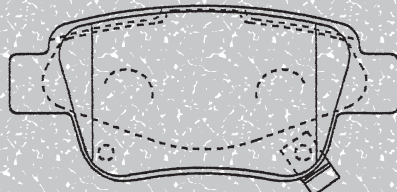

X: 102.0 Y: 44.0 Z: 15.0

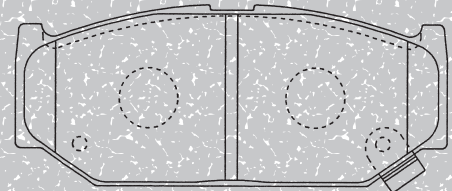

X: 108.6 Y: 44.0 Z: 14.5

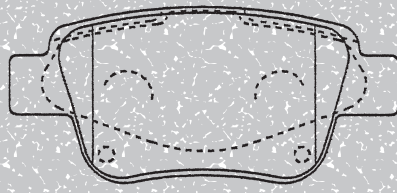

X: 102.0 Y: 44.0 Z: 15.0

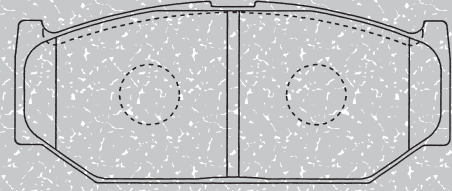

X: 108.6 Y: 44.0 Z: 14.5

MN-446M

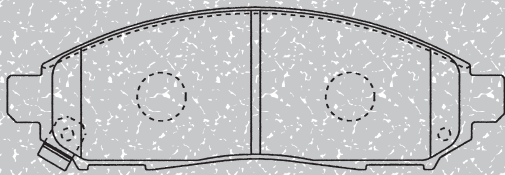

X: 163.7 Y: 50.0 Z: 15.5

MN-449

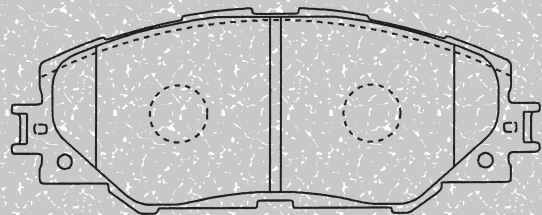

X: 146.7 Y: 52.0 Z: 17.0

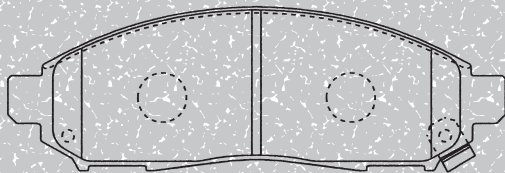

X: 163.7 Y: 50.0 Z: 15.5

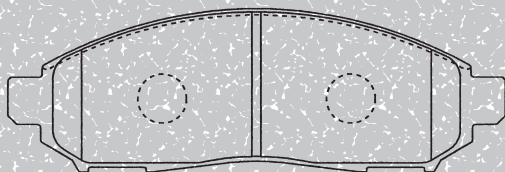

X: 163.7 Y: 50.0 Z: 15.5

BRAKE PADS

MN-450 (リヤ)

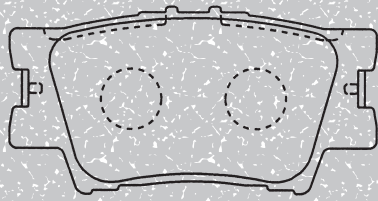

X: 96.9 Y: 44.5 Z: 15.0

MN-451

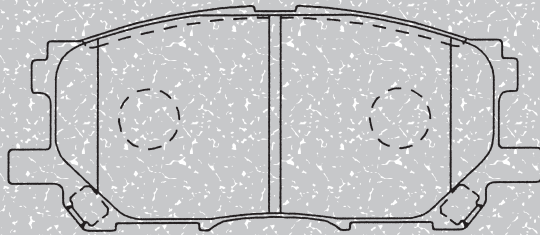

X: 141.0 Y: 54.5 Z: 16.5

MN-452 (リヤ)

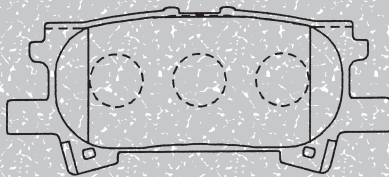

X: 101.8 Y: 36.5 Z: 15.0

MN-453

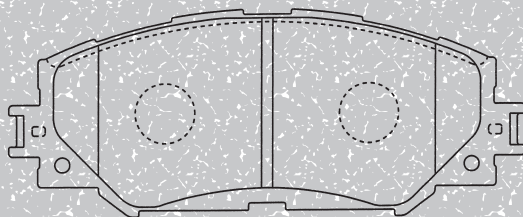

X: 139.0 Y: 50.6 Z: 17.0

MN-454

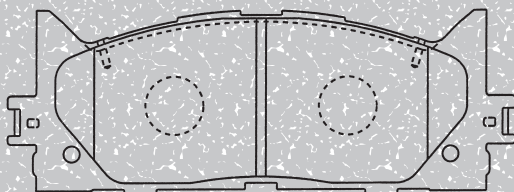

X: 157.7 Y: 52.1 Z: 17.5

MN-455M

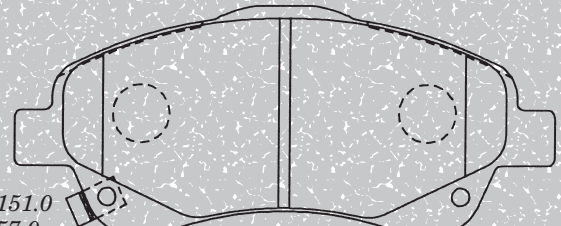

X: 151.0
Y: 57.0
Z: 17.5

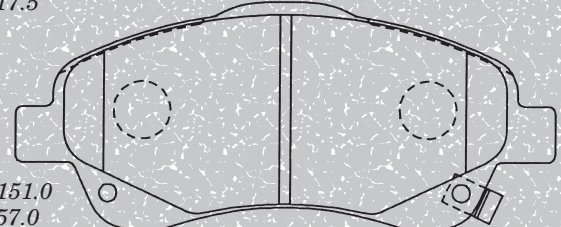

X: 151.0
Y: 57.0
Z: 17.5

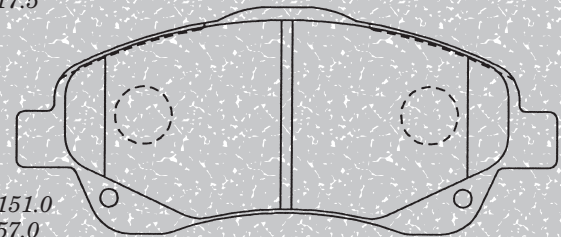

X: 151.0
Y: 57.0
Z: 17.5

MN-456 (リヤ)

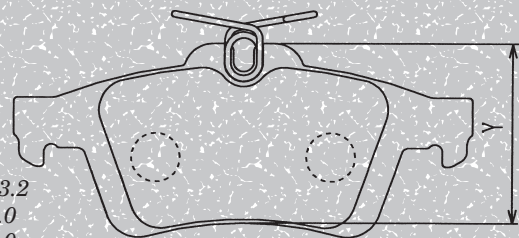

X: 123.2
Y: 48.0
Z: 15.0

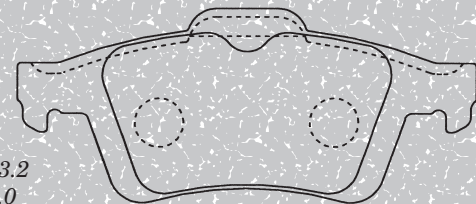

X: 123.2
Y: 48.0
Z: 15.0

スプリング同梱

インナー背面に針金状リテーナ付きのパッドにも使えます。

MN-457M (リヤ)

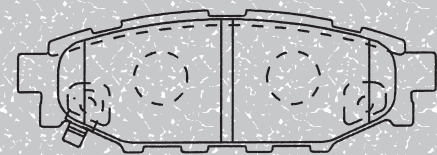

X: 110.3
Y: 34.5
Z: 13.5

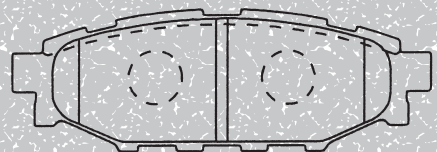

X: 110.3
Y: 34.5
Z: 13.5

BRAKE PADS

MN-458M (リヤ)

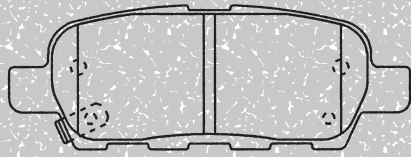

X: 105.5 Y: 35.0 Z: 14.0

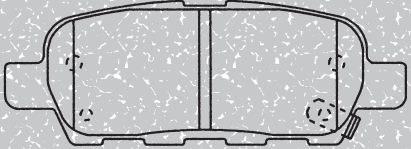

X: 105.5 Y: 35.0 Z: 14.0

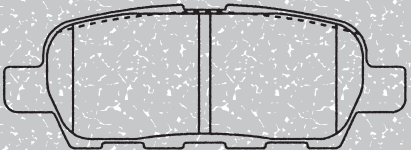

X: 105.5 Y: 35.0 Z: 14.0

MN-459

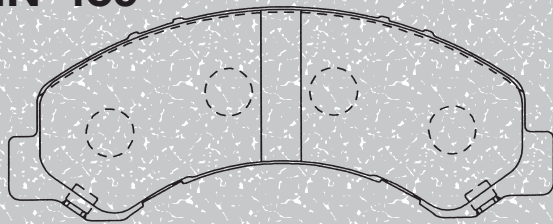

X: 206.3 Y: 59.0 Z: 20.0

MN-460M

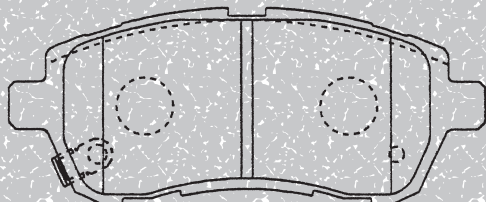

X: 125.7 Y: 45.5 Z: 15.0

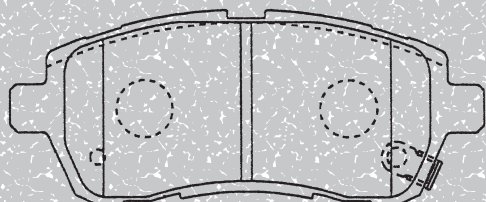

X: 125.7 Y: 45.5 Z: 15.0

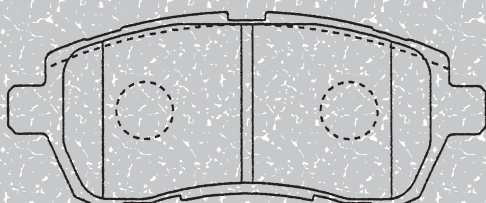

X: 125.7 Y: 45.5 Z: 15.0

MN-461

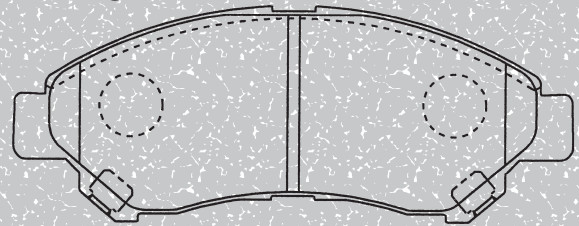

X: 142.0 Y: 47.0 Z: 15.5

MN-462

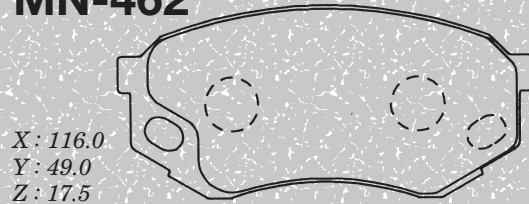

X: 116.0
Y: 49.0
Z: 17.5

1枚

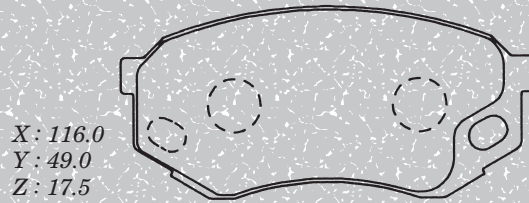

X: 116.0
Y: 49.0
Z: 17.5

1枚

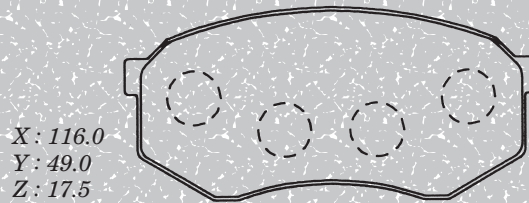

X: 116.0
Y: 49.0
Z: 17.5

6枚

MN-463 (フロント&リヤ)

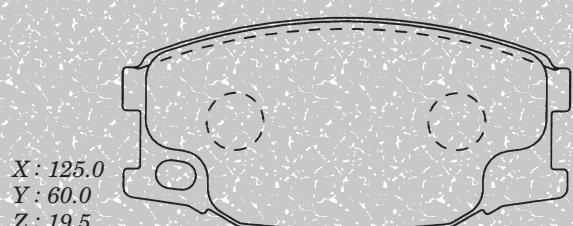

X: 125.0
Y: 60.0
Z: 19.5

1枚

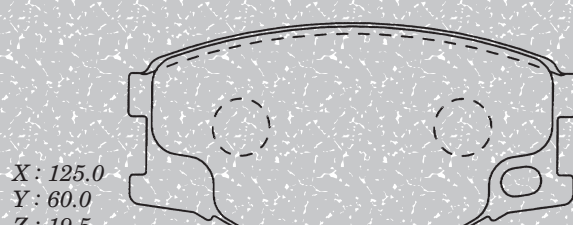

X: 125.0
Y: 60.0
Z: 19.5

1枚

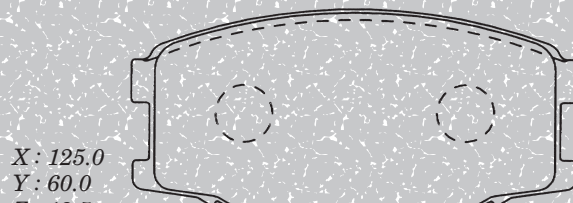

X: 125.0
Y: 60.0
Z: 19.5

6枚

BRAKE PADS

MN-464 (フロント&リヤ)

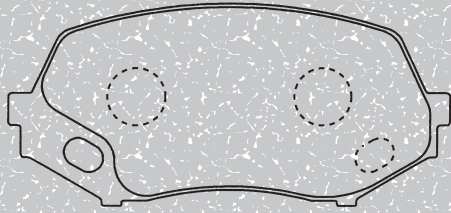

1枚

X: 123.0 Y: 52.0 Z: 17.5

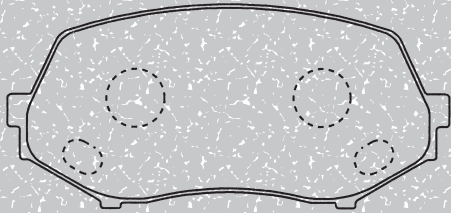

7枚

X: 123.0 Y: 52.0 Z: 17.5

MN-466 (フロント&リヤ)

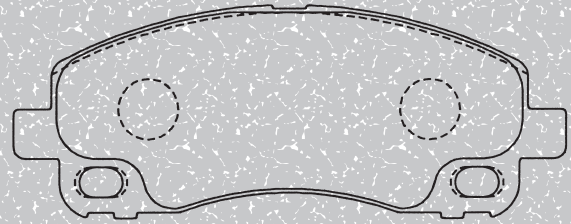

X: 147.2 Y: 48.5 Z: 18.0

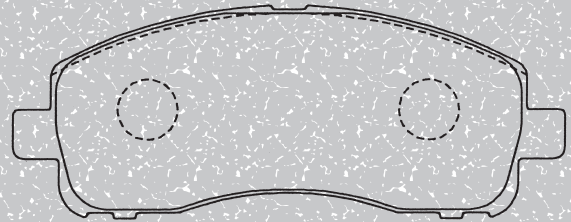

X: 147.2 Y: 48.5 Z: 18.0

MN-465 (フロント&リヤ)

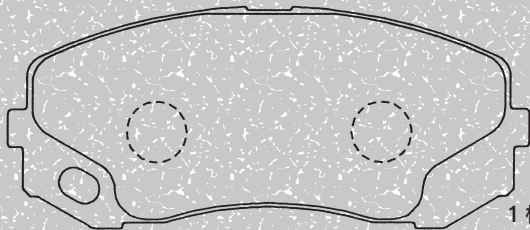

1枚

X: 139.0 Y: 52.0 Z: 19.5

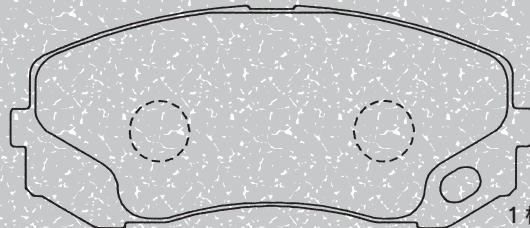

1枚

X: 139.0 Y: 52.0 Z: 19.5

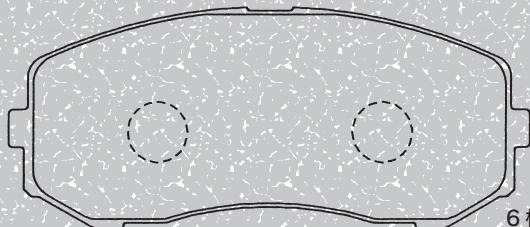

6枚

X: 139.0 Y: 52.0 Z: 19.5

MN-467

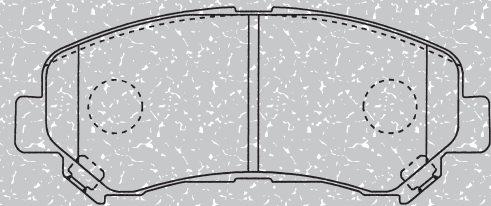

X: 142.0 Y: 50.0 Z: 16.5

MN-468M

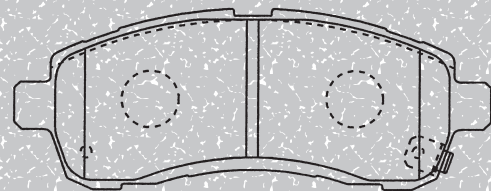

X: 125.7 Y: 40.8 Z: 14.5

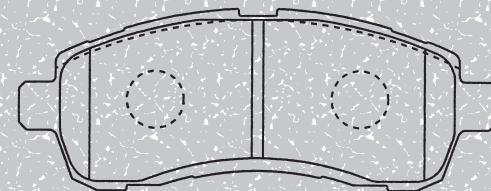

X: 125.7 Y: 40.8 Z: 14.5

摩耗センサー付きパッドは車両左側の内側に組付けてください。

BRAKE PADS

MN-469M

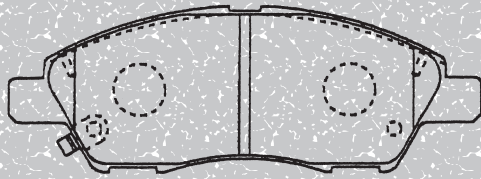

X: 138.7 Y: 43.0 Z: 13.5

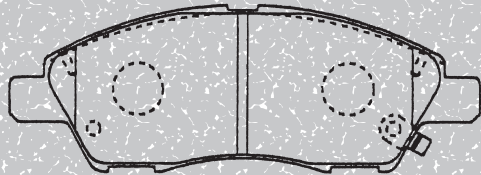

X: 138.7 Y: 43.0 Z: 13.5

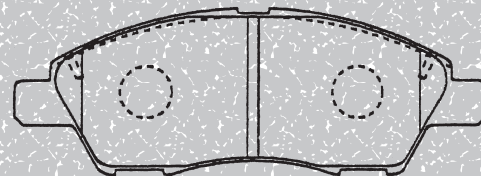

X: 138.7 Y: 43.0 Z: 13.5

MN-471M

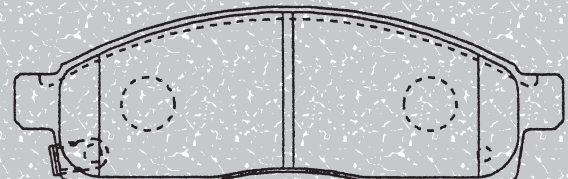

X: 155.5 Y: 46.5 Z: 16.5

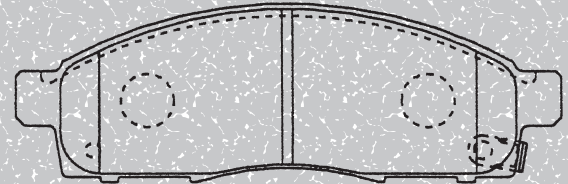

X: 155.5 Y: 46.5 Z: 16.5

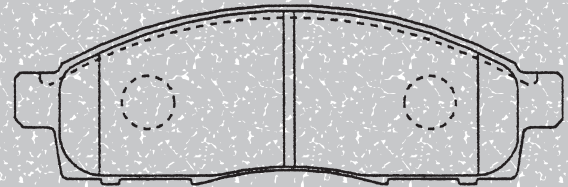

X: 155.5 Y: 46.5 Z: 16.5

MN-470

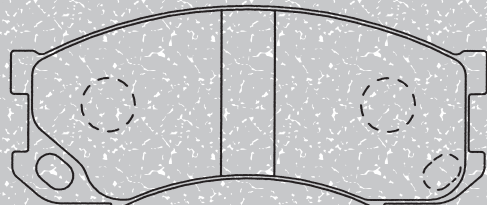

X: 133.0 Y: 48.0 Z: 17.5

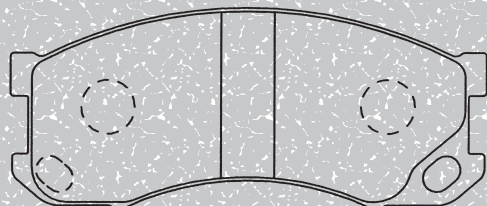

X: 133.0 Y: 48.0 Z: 17.5

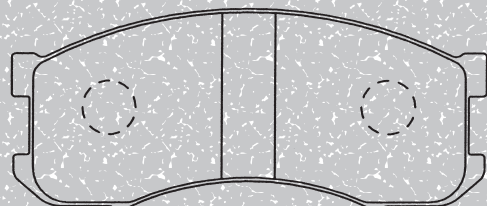

X: 133.0 Y: 48.0 Z: 17.5

MN-472M

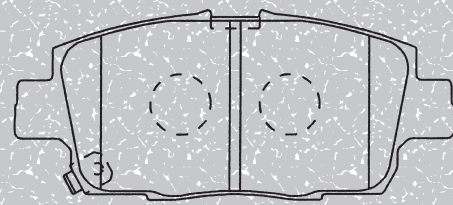

X: 116.6 Y: 47.0 Z: 16.0

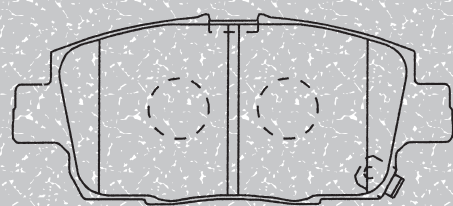

X: 116.6 Y: 47.0 Z: 16.0

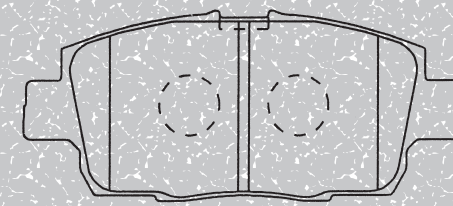

X: 116.6 Y: 47.0 Z: 16.0

BRAKE PADS

MN-473M

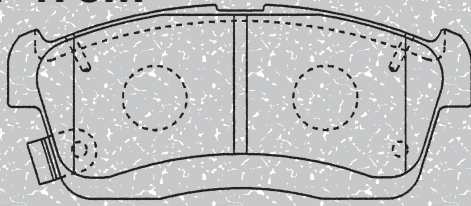

X: 108.6 Y: 41.5 Z: 15.0

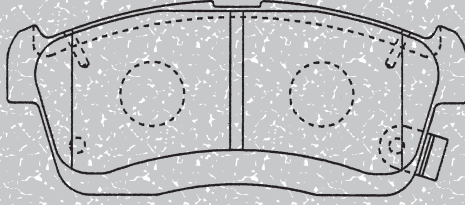

X: 108.6 Y: 41.5 Z: 15.0

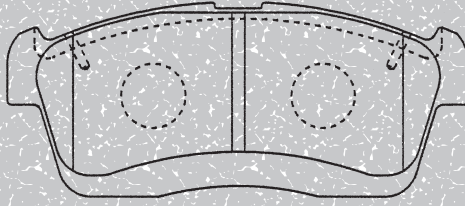

X: 108.6 Y: 41.5 Z: 15.0

MN-476

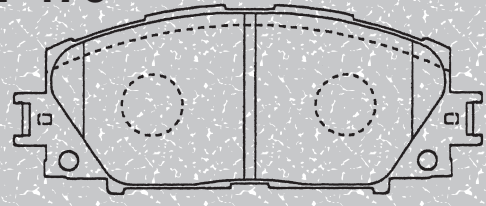

X: 123.5 Y: 45.7 Z: 15.0

MN-477M (リヤ)

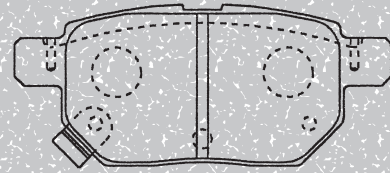

X: 98.6 Y: 40.0 Z: 14.5

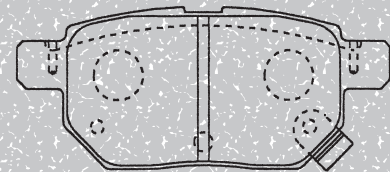

X: 98.6 Y: 40.0 Z: 14.5

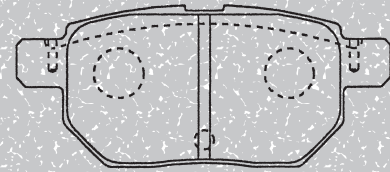

X: 98.6 Y: 40.0 Z: 14.5

MN-474 (フロント&リヤ)

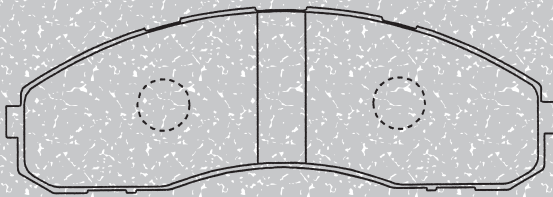

X: 170.2 Y: 49.0 Z: 18.0

MN-475

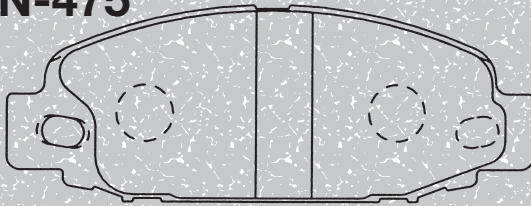

X: 140.2 Y: 51.0 Z: 18.0

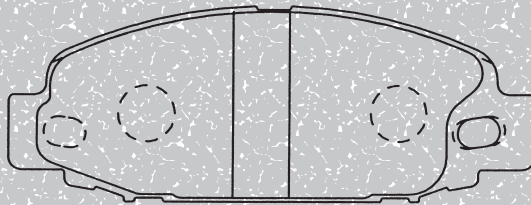

X: 140.2 Y: 51.0 Z: 18.0

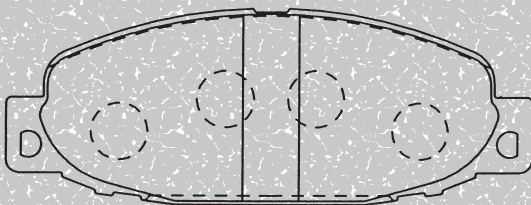

X: 140.2 Y: 51.0 Z: 18.0

MN-478M

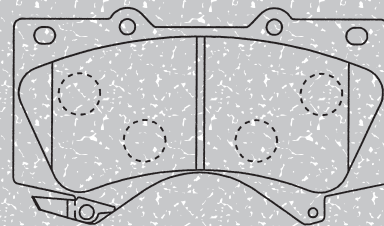

*X: 143.8
Y: 56.0
Z: 17.5*

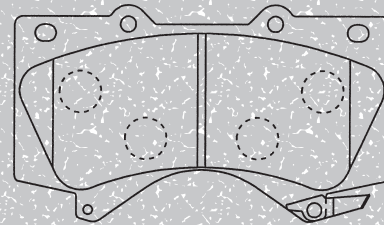

*X: 143.8
Y: 56.0
Z: 17.5*

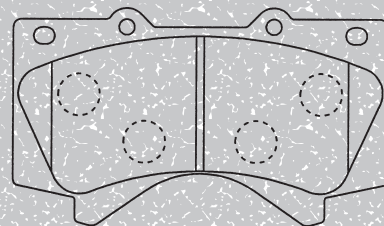

*X: 143.8
Y: 56.0
Z: 17.5*

BRAKE PADS

MN-479 (リヤ)

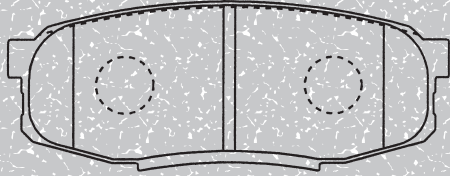

X: 116.0 Y: 42.5 Z: 17.0

MN-481M (リヤ)

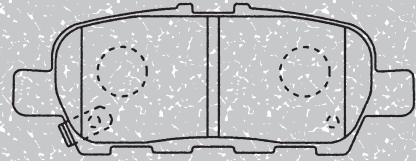

X: 105.5 Y: 35.0 Z: 14.0

MN-480M

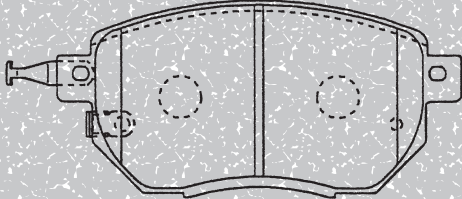

X: 135.8 Y: 62.5 Z: 15.0

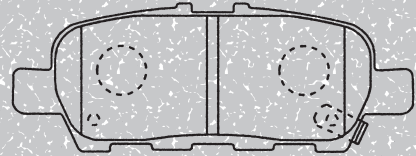

X: 105.5 Y: 35.0 Z: 14.0

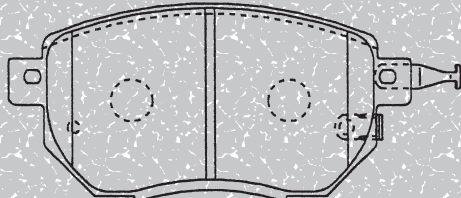

X: 135.8 Y: 62.5 Z: 15.0

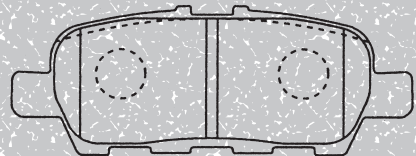

X: 105.5 Y: 35.0 Z: 14.0

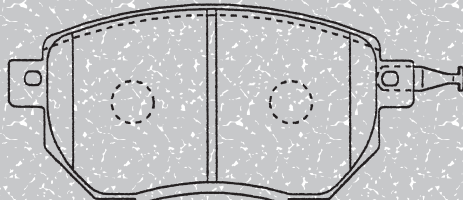

X: 135.8 Y: 62.5 Z: 15.0

MN-482M

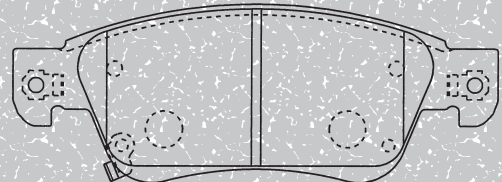

X: 158.3 Y: 54.2 Z: 15.5

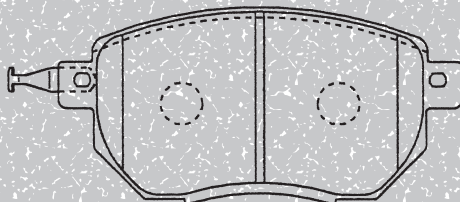

X: 135.8 Y: 62.5 Z: 15.0

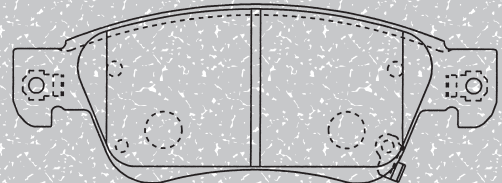

X: 158.3 Y: 54.2 Z: 15.5

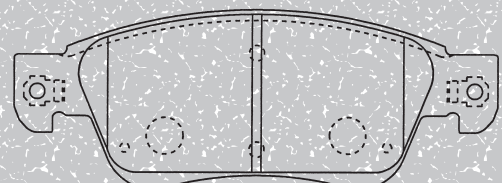

X: 158.3 Y: 54.2 Z: 15.5

BRAKE PADS

MN-483M (リヤ)

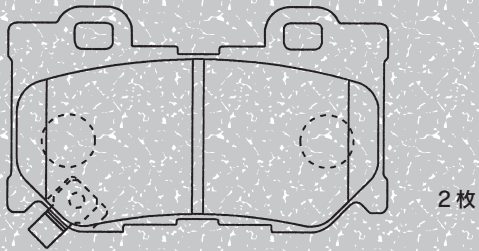

X: 99.8 Y: 43.7 Z: 13.5

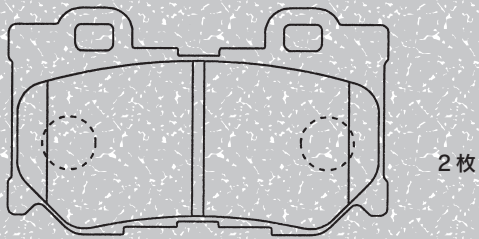

X: 99.8 Y: 43.7 Z: 13.5

MN-485M

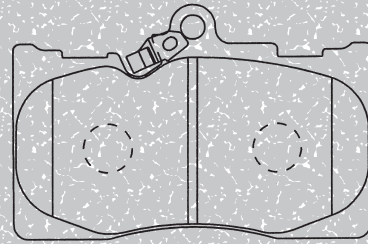

X: 118.6 Y: 73.5 Z: 17.0

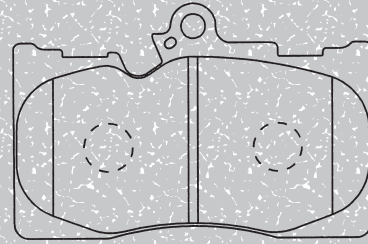

X: 118.6 Y: 73.5 Z: 17.0

MN-484M

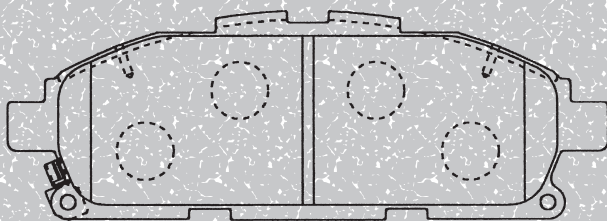

X: 158.8 Y: 52.0 Z: 15.0

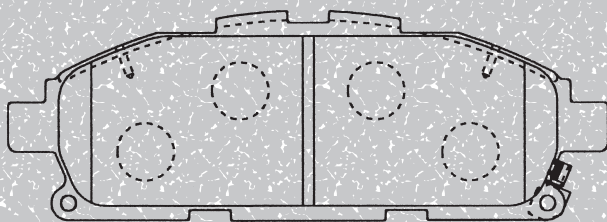

X: 158.8 Y: 52.0 Z: 15.0

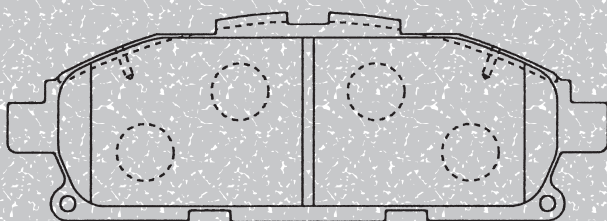

X: 158.8 Y: 52.0 Z: 15.0

MN-486

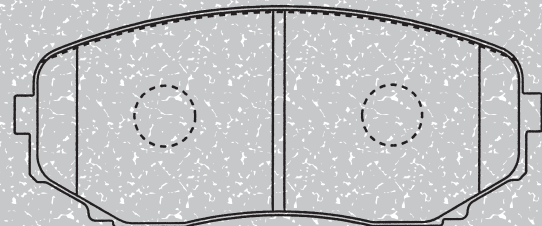

X: 139.0 Y: 55.0 Z: 17.0

MN-487 (リヤ)

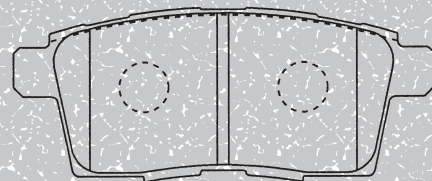

X: 110.7 Y: 42.4 Z: 16.5

BRAKE PADS

MN-488M

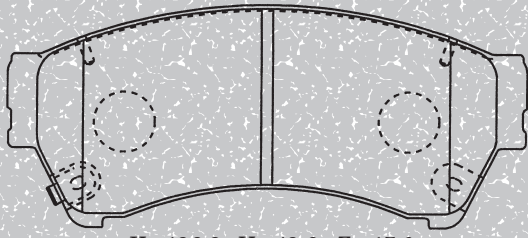

X:136.8 Y:48.6 Z:17.0

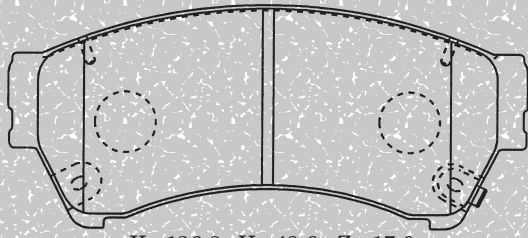

X:136.8 Y:48.6 Z:17.0

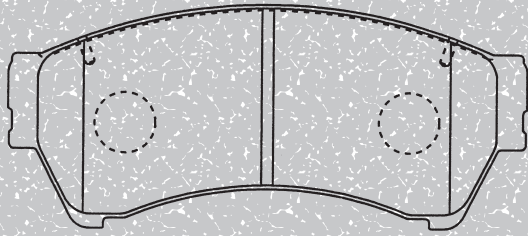

X:136.8 Y:48.6 Z:17.0

MN-492M

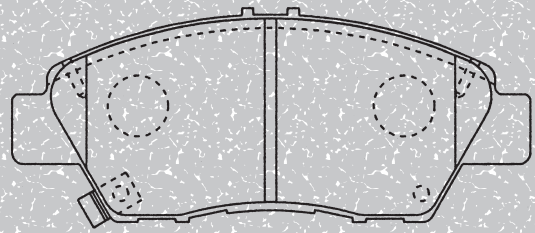

X:136.5 Y:51.4 Z:15.5

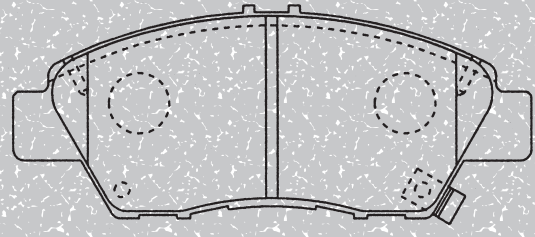

X:136.5 Y:51.4 Z:15.5

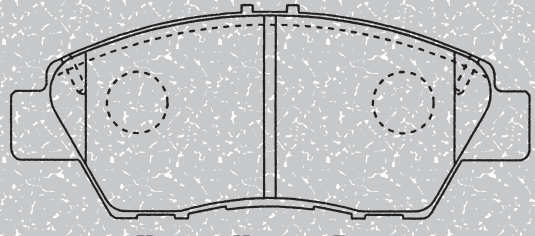

X:136.5 Y:51.4 Z:15.5

MN-489

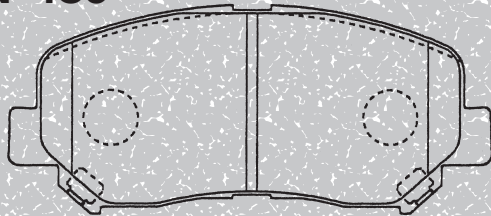

X:142.0 Y:54.0 Z:15.5

MN-493M

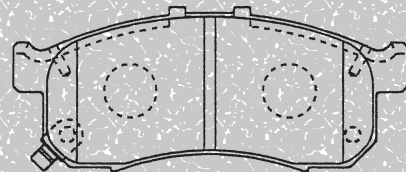

X:104.0 Y:37.0 Z:14.0

MN-490(リヤ)

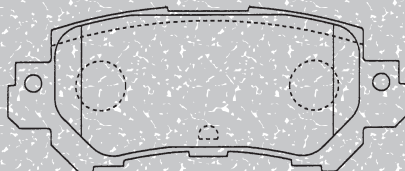

X:104.7 Y:38.0 Z:14.0

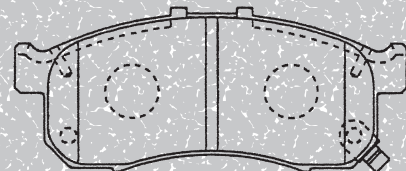

X:104.0 Y:37.0 Z:14.0

MN-491

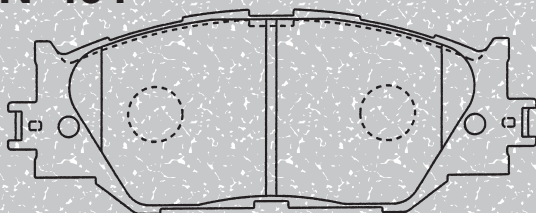

X:154.7 Y:54.0 Z:17.0

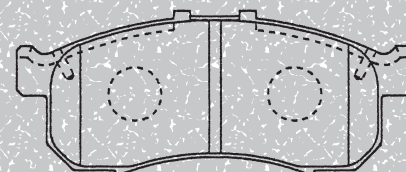

X:104.0 Y:37.0 Z:14.0

BRAKE PADS

MN-494M

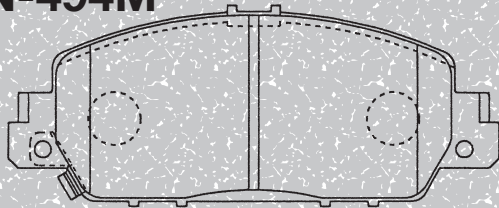

X: 148.8 Y: 57.5 Z: 16.0

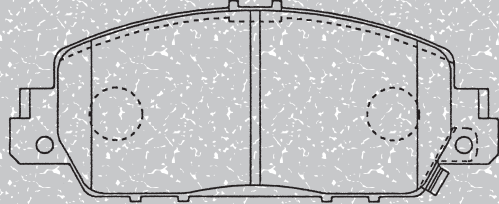

X: 148.8 Y: 57.5 Z: 16.0

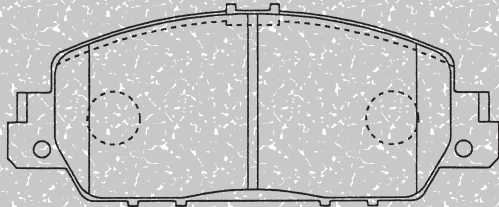

X: 148.8 Y: 57.5 Z: 16.0

MN-497M (リヤ)

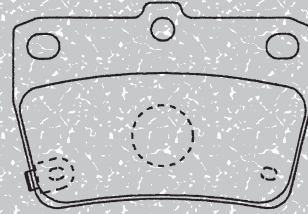

X: 78.5 Y: 47.5 Z: 13.5

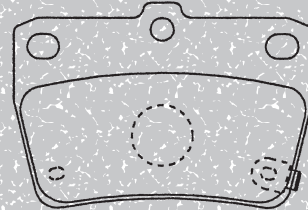

X: 78.5 Y: 47.5 Z: 13.5

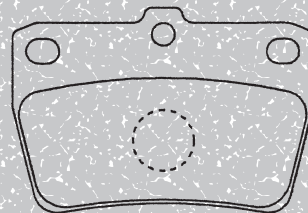

X: 78.5 Y: 47.5 Z: 13.5

MN-495 (リヤ)

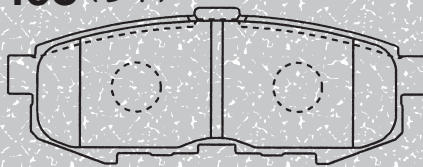

X: 110.4 Y: 36.1 Z: 15.5

MN-498M

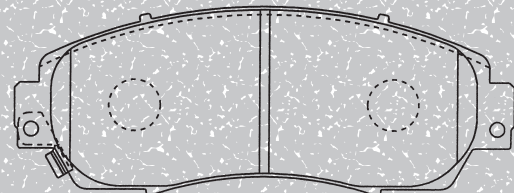

X: 154.8 Y: 53.0 Z: 17.5

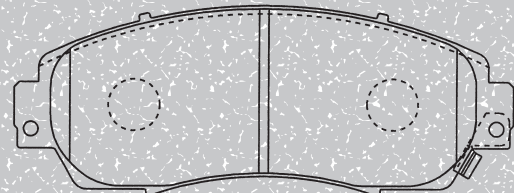

X: 154.8 Y: 53.0 Z: 17.5

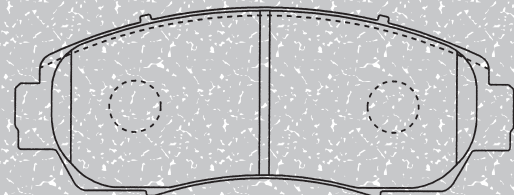

X: 154.8 Y: 53.0 Z: 17.5

MN-496M

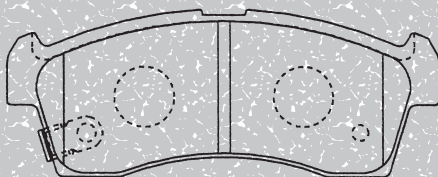

X: 108.6 Y: 35.5 Z: 14.5

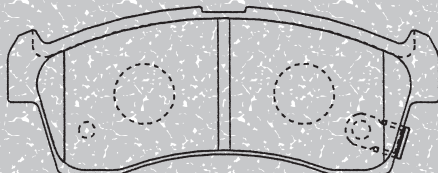

X: 108.6 Y: 35.5 Z: 14.5

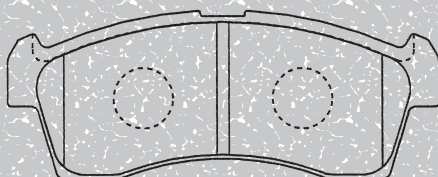

X: 108.6 Y: 35.5 Z: 14.5

BRAKE PADS

MN-499M (フロント&リヤ)

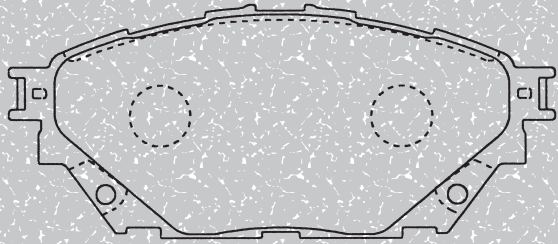

X: 144.3 Y: 58.2 Z: 19.5 4枚

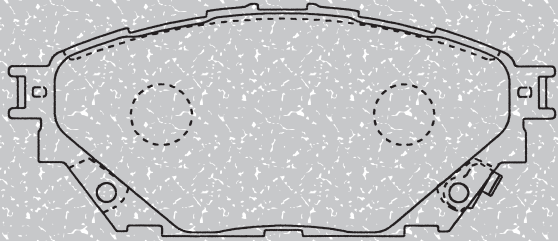

X: 144.3 Y: 58.2 Z: 19.5 2枚

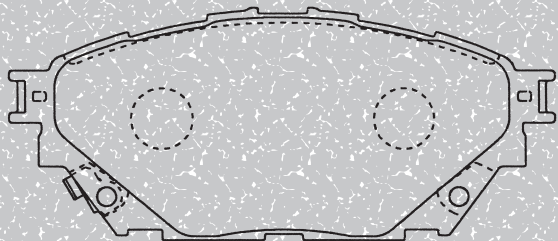

X: 144.3 Y: 58.2 Z: 19.5 2枚

MN-501M (リヤ)

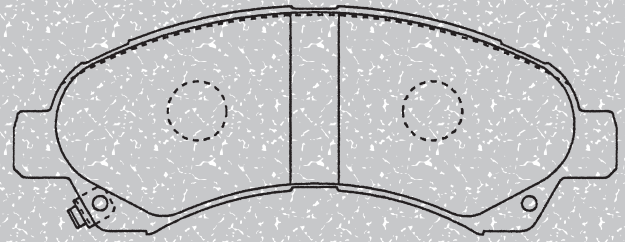

X: 163.6 Y: 48.5 Z: 19.5

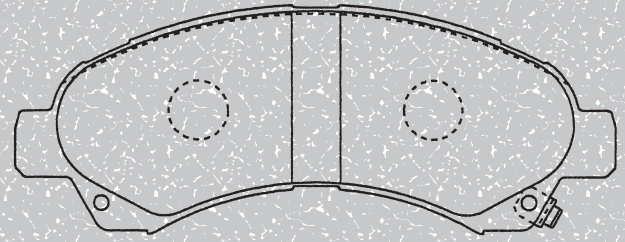

X: 163.6 Y: 48.5 Z: 19.5

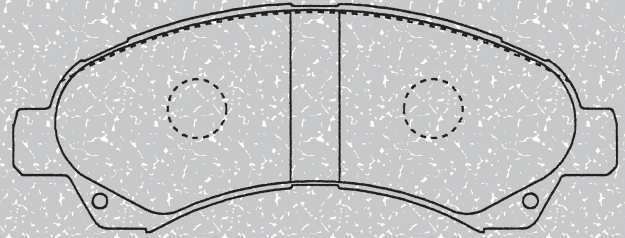

X: 163.6 Y: 48.5 Z: 19.5

MN-500M

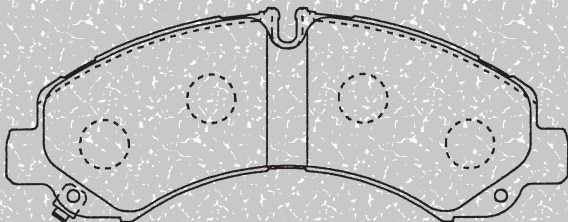

X: 184.2 Y: 41.3 Z: 19.5

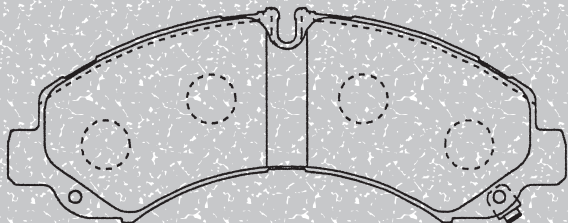

X: 184.2 Y: 41.3 Z: 19.5

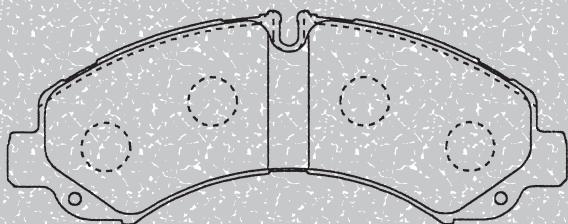

X: 184.2 Y: 41.3 Z: 19.5

MN-502M

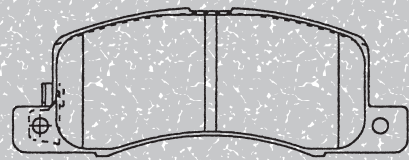

X: 103.5 Y: 32.5 Z: 14.5

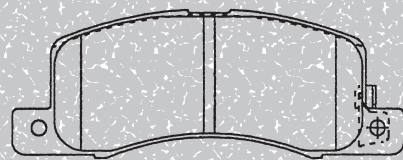

X: 103.5 Y: 32.5 Z: 14.5

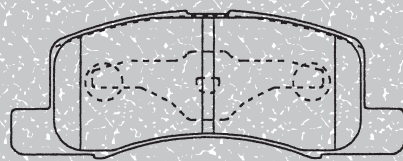

X: 103.5 Y: 32.5 Z: 14.5

BRAKE PADS

MN-503M

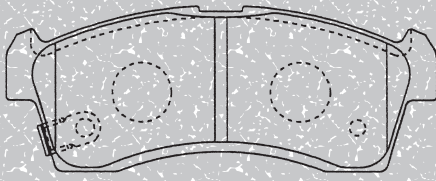

X: 108.6 Y: 35.5 Z: 13.5

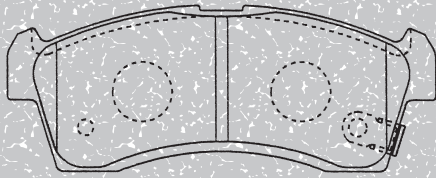

X: 108.6 Y: 35.5 Z: 13.5

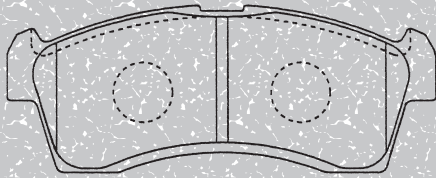

X: 108.6 Y: 35.5 Z: 13.5

MN-505M (リヤ)

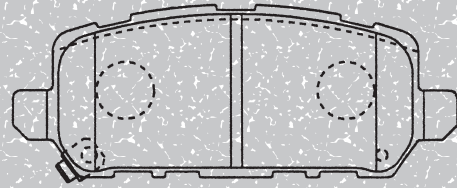

X: 116.7 Y: 44.0 Z: 15.5

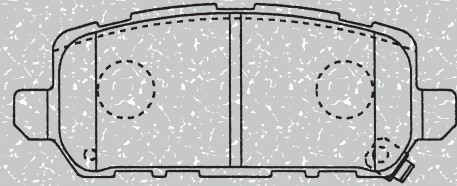

X: 116.7 Y: 44.0 Z: 15.5

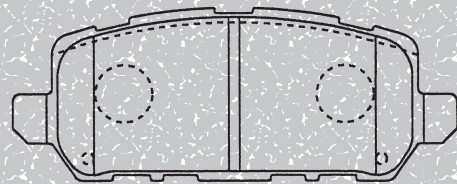

X: 116.7 Y: 44.0 Z: 15.5

MN-504M (フロント&リヤ)

*X: 206.3
Y: 59.0
Z: 20.0*

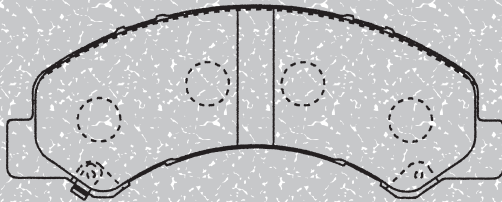

*X: 206.3
Y: 59.0
Z: 20.0*

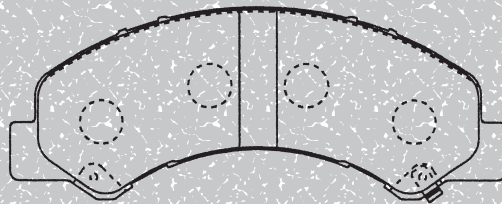

*X: 206.3
Y: 59.0
Z: 20.0*

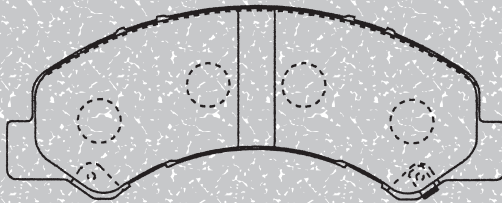

*X: 206.3
Y: 59.0
Z: 20.0*

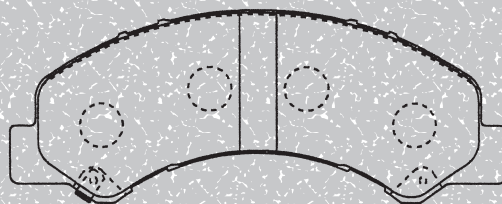

MN-506M

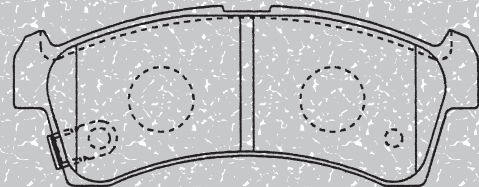

X: 108.6 Y: 33.5 Z: 14.5

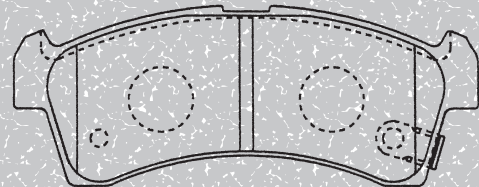

X: 108.6 Y: 33.5 Z: 14.5

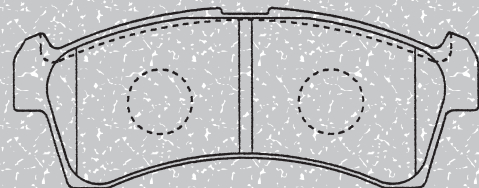

X: 108.6 Y: 33.5 Z: 14.5

BRAKE PADS

MN-507 (リヤ)

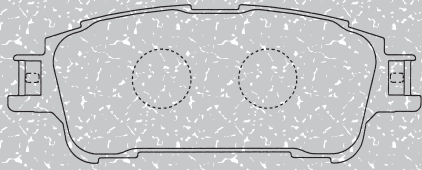

X: 112.6 Y: 38.5 Z: 16.0

MN-508 (リヤ)

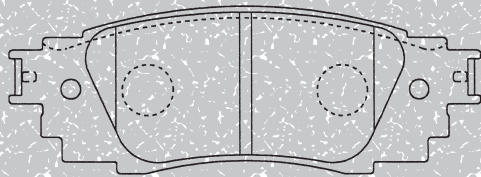

X: 121.2 Y: 39.5 Z: 14.5

MN-509 (リヤ)

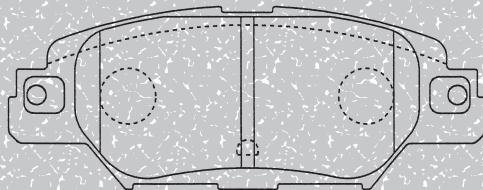

X: 112.2 Y: 41.3 Z: 14.0

MN-510M

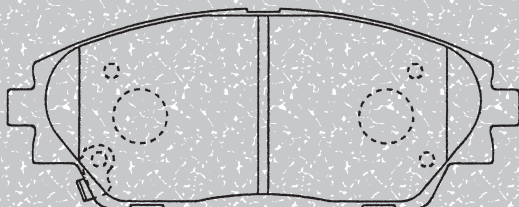

X: 142.0 Y: 54.5 Z: 15.5

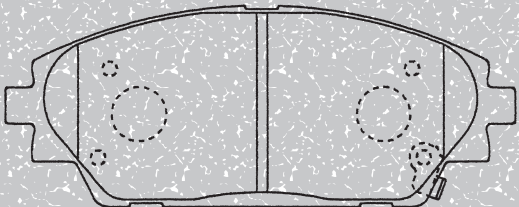

X: 142.0 Y: 54.5 Z: 15.5

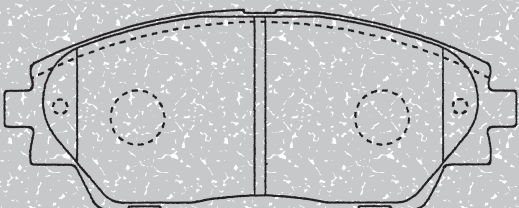

X: 142.0 Y: 54.5 Z: 15.5

MN-511M (リヤ)

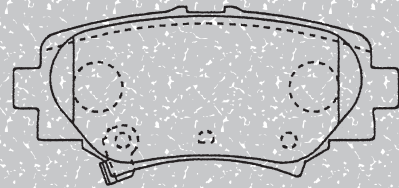

X: 101.5 Y: 38.5 Z: 13.5

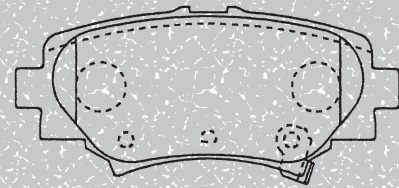

X: 101.5 Y: 38.5 Z: 13.5

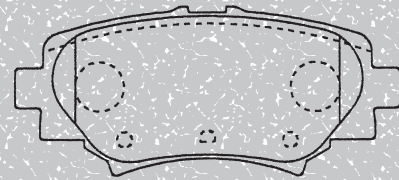

X: 101.5 Y: 38.5 Z: 13.5

MN-512M

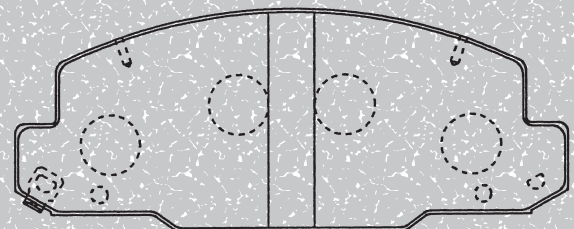

X: 166.6 Y: 67.0 Z: 20.0

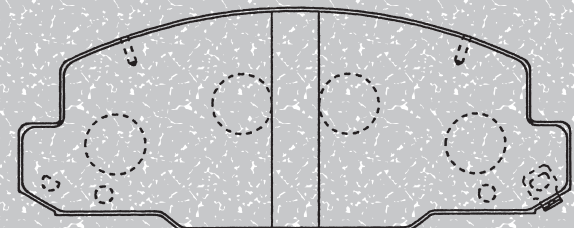

X: 166.6 Y: 67.0 Z: 20.0

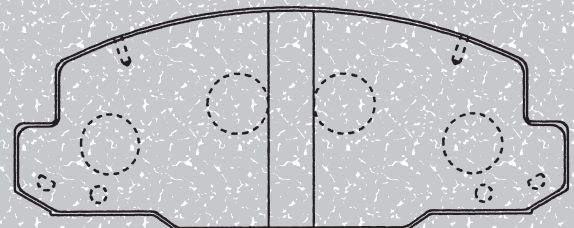

X: 166.6 Y: 67.0 Z: 20.0

BRAKE PADS

MN-513

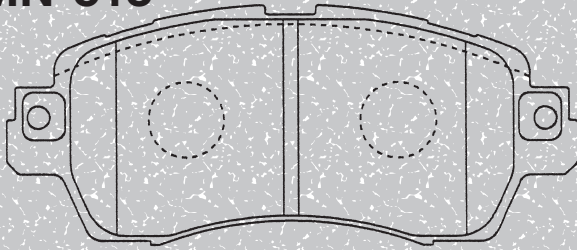

X: 113.7 Y: 41.0 Z: 14.5

MN-516

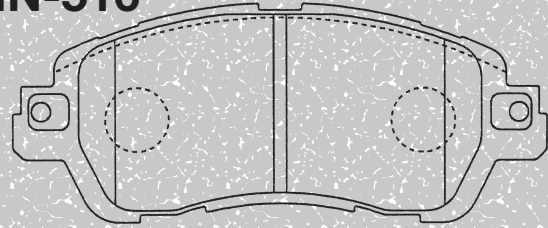

X: 125.7 Y: 45.3 Z: 15.0

MN-514M

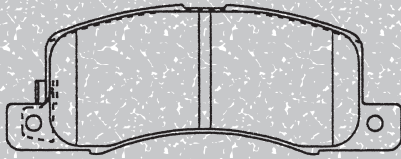

X: 103.5 Y: 32.5 Z: 14.5

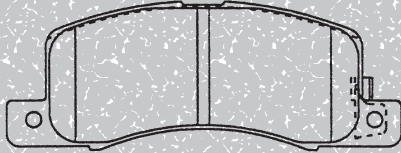

X: 103.5 Y: 32.5 Z: 14.5

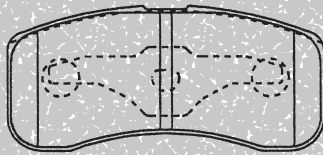

X: 83.0 Y: 32.5 Z: 14.5

MN-517

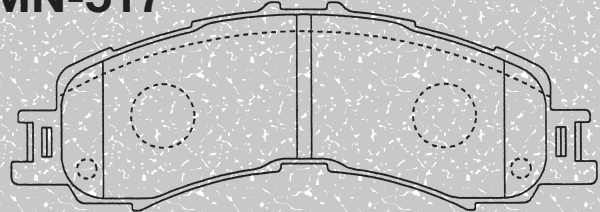

X: 120.7 Y: 31.5 Z: 15.0

MN-518M

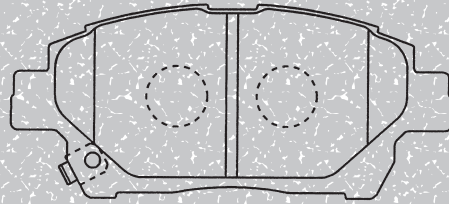

X: 116.6 Y: 47.0 Z: 16.0

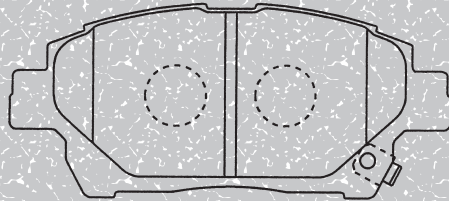

X: 116.6 Y: 47.0 Z: 16.0

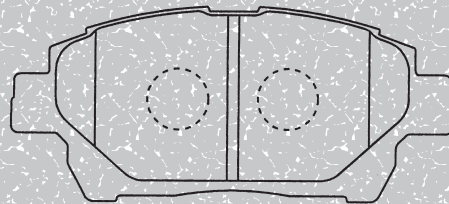

X: 116.6 Y: 47.0 Z: 16.0

MN-515M (リヤ)

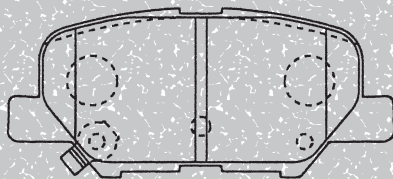

X: 101.4 Y: 40.0 Z: 14.0

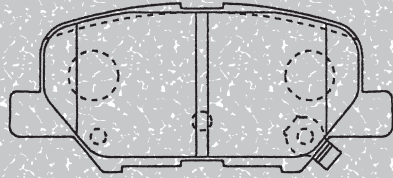

X: 101.4 Y: 40.0 Z: 14.0

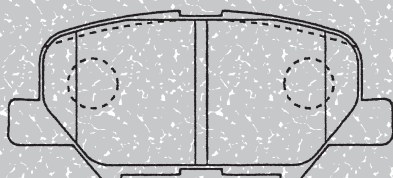

X: 101.4 Y: 40.0 Z: 14.0

MN-519

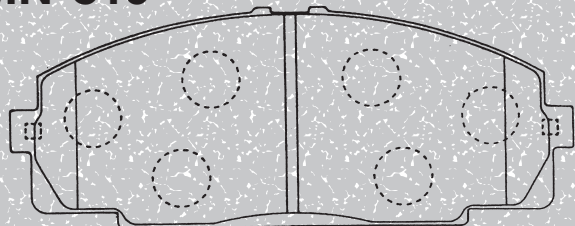

X: 145.5 Y: 55.5 Z: 15.5

BRAKE PADS

MN-520M (リヤ)

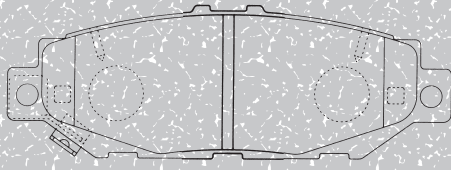

X: 121.9 Y: 38.0 Z: 15.5

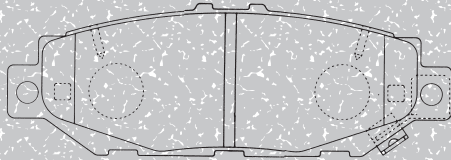

X: 121.9 Y: 38.0 Z: 15.5

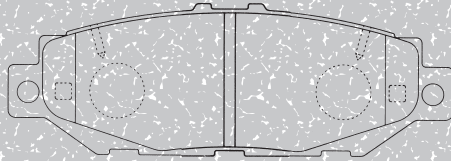

X: 121.9 Y: 38.0 Z: 15.5

MN-523M (リヤ)

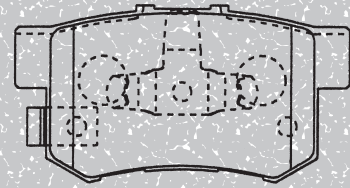

X: 88.7 Y: 42.5 Z: 14.5

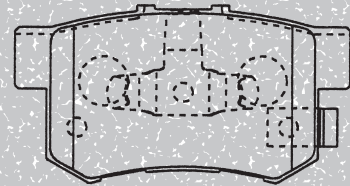

X: 88.7 Y: 42.5 Z: 14.5

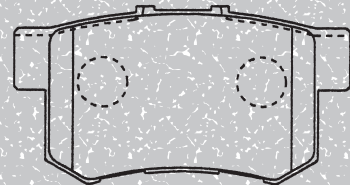

X: 88.7 Y: 42.5 Z: 14.5

MN-521

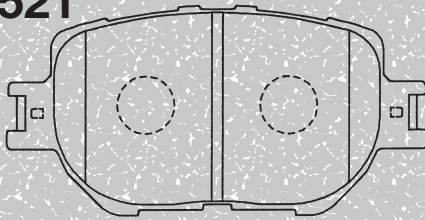

X: 117.7 Y: 54.5 Z: 17.0

MN-524M (リヤ)

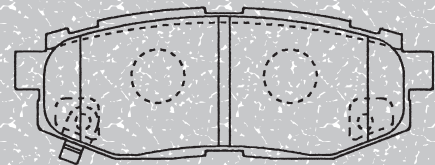

X: 110.3 Y: 36.1 Z: 15.5

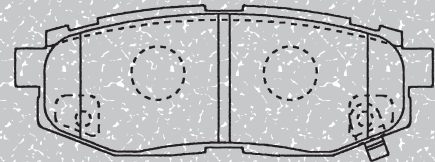

X: 110.3 Y: 36.1 Z: 15.5

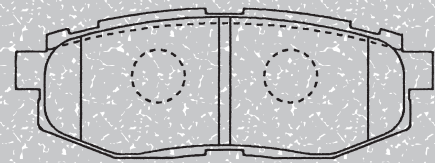

X: 110.3 Y: 36.1 Z: 15.5

MN-522M

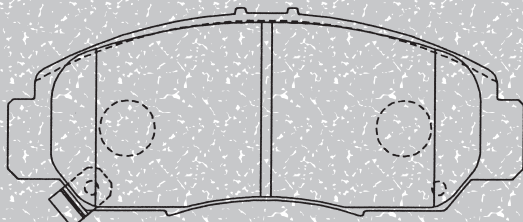

X: 148.8 Y: 53.5 Z: 17.0

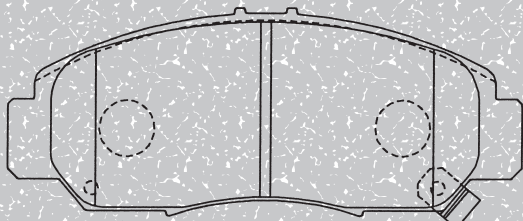

X: 148.8 Y: 53.5 Z: 17.0

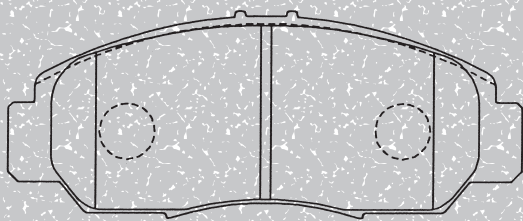

X: 148.8 Y: 53.5 Z: 17.0

BRAKE PADS

MN-525M

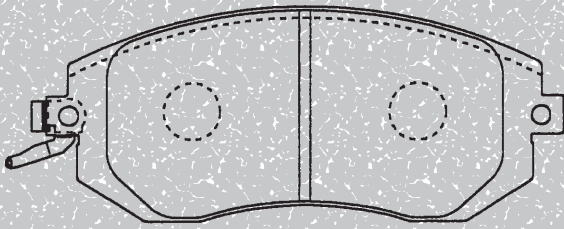

X: 137.0 Y: 52.5 Z: 16.5

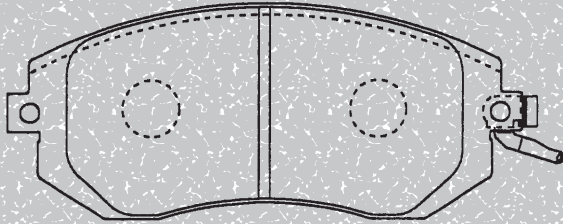

X: 137.0 Y: 52.5 Z: 16.5

MN-528M (リヤ)

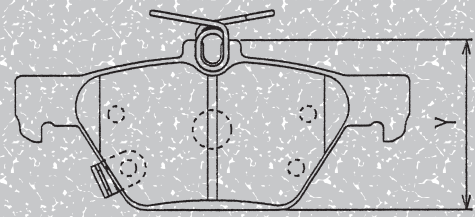

X: 123.2
Y: 52.5
Z: 13.5

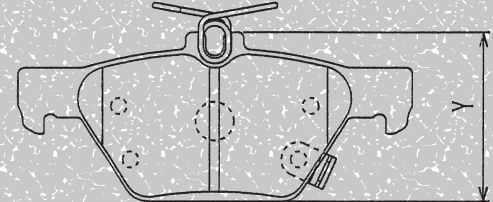

X: 123.2
Y: 52.5
Z: 13.5

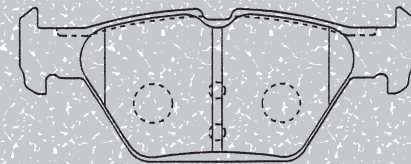

X: 123.2
Y: 44.0
Z: 13.5

スプリング同梱

MN-526M

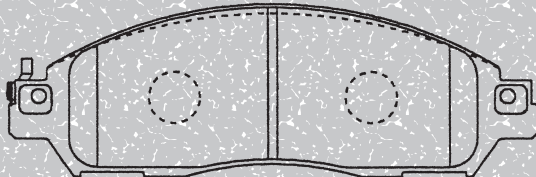

X: 165.5 Y: 50.0 Z: 15.0

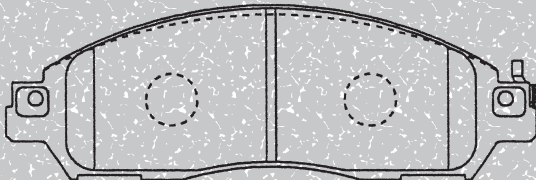

X: 165.5 Y: 50.0 Z: 15.0

MN-529

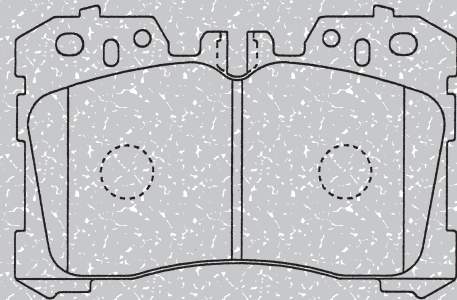

X: 133.7 Y: 56.0 Z: 18.0

MN-527 (リヤ)

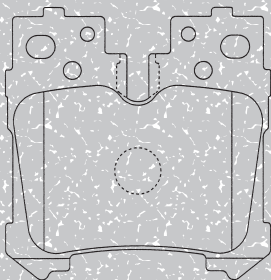

X: 75.1 Y: 41.5 Z: 18.0

MN-530

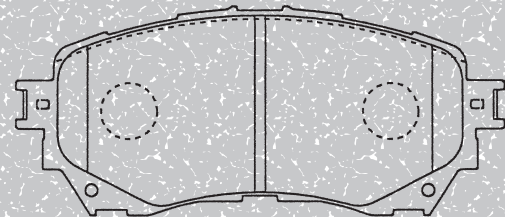

X: 140.2 Y: 52.8 Z: 15.0

MN-531

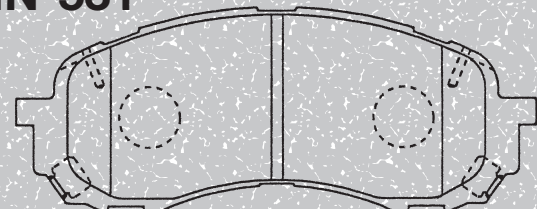

X: 137.0 Y: 45.5 Z: 16.5

BRAKE PADS

MN-532M

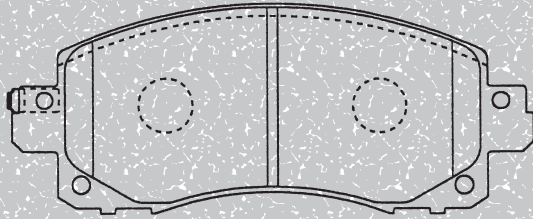

X: 145.3 Y: 52.5 Z: 16.5

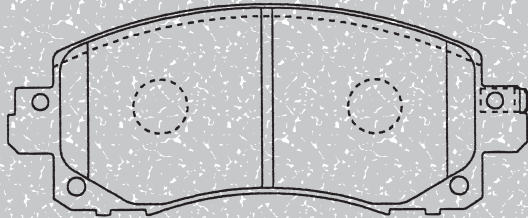

X: 145.3 Y: 52.5 Z: 16.5

MN-535M

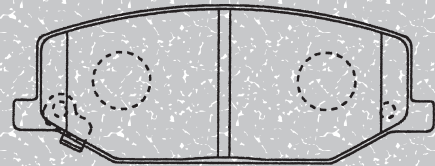

X: 110.5 Y: 41.5 Z: 14.5

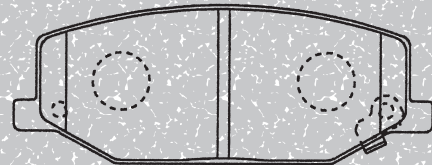

X: 110.5 Y: 41.5 Z: 14.5

MN-533

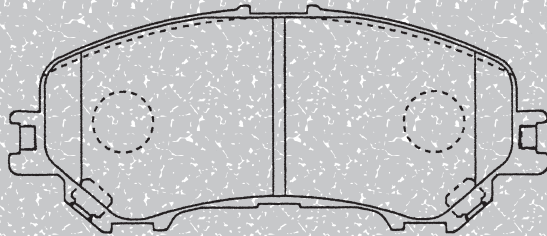

X: 142.0 Y: 50.0 Z: 17.0

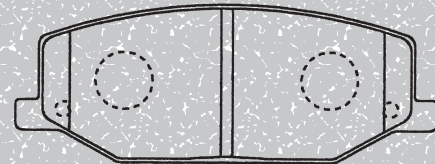

X: 110.5 Y: 41.5 Z: 14.5

MN-534M

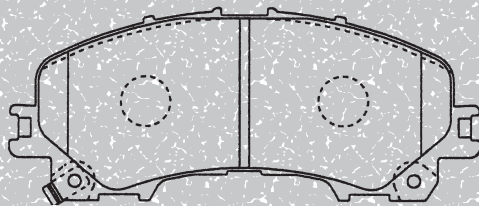

X: 152.0 Y: 50.0 Z: 15.5

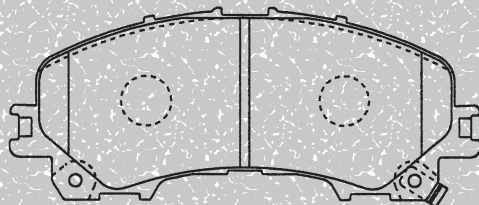

X: 152.0 Y: 50.0 Z: 15.5

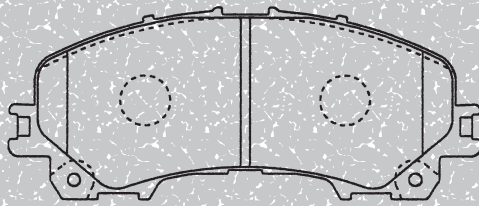

X: 152.0 Y: 50.0 Z: 15.5

MN-536M

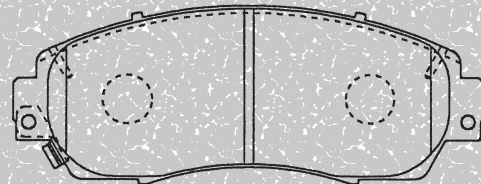

X: 154.8 Y: 53.0 Z: 17.5

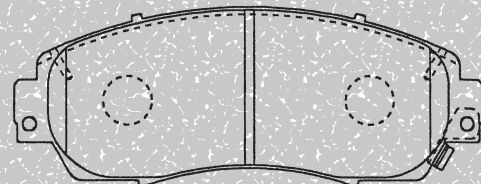

X: 154.8 Y: 53.0 Z: 17.5

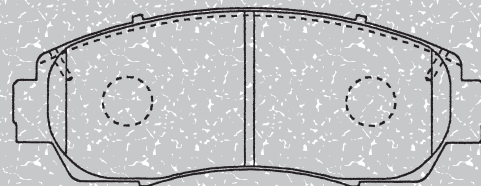

X: 154.8 Y: 53.0 Z: 17.5

BRAKE PADS

MN-537M

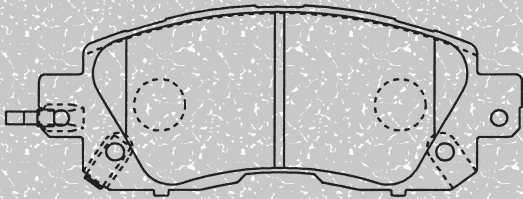

X: 141.7 Y: 48.7 Z: 15.5

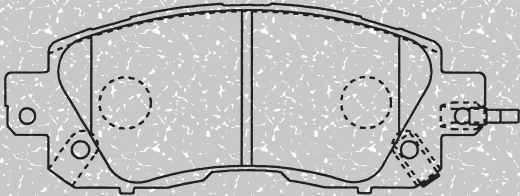

X: 141.7 Y: 48.7 Z: 15.5

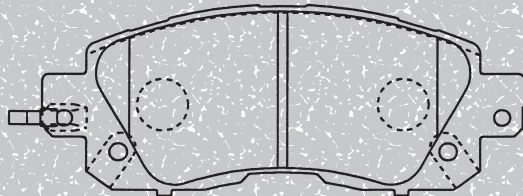

X: 141.7 Y: 48.7 Z: 15.5

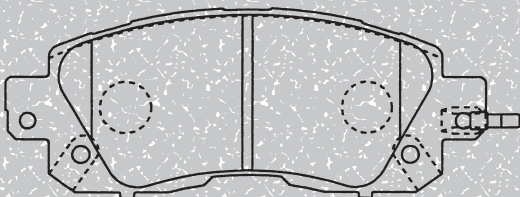

X: 141.7 Y: 48.7 Z: 15.5

スプリング同梱

MN-538M (リヤ)

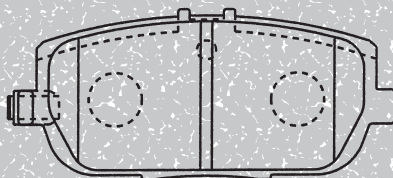

X: 99.0 Y: 42.0 Z: 13.5

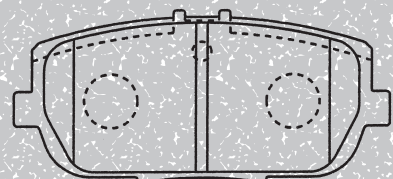

X: 99.0 Y: 42.0 Z: 13.5

センサー同梱

MN-539M (リヤ)

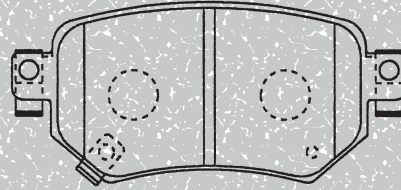

X: 104.0 Y: 44.0 Z: 14.0

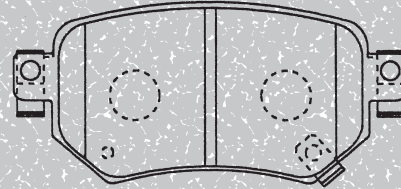

X: 104.0 Y: 44.0 Z: 14.0

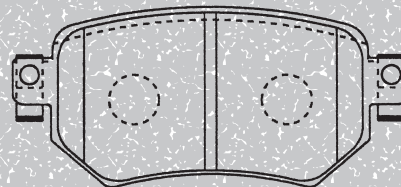

X: 104.0 Y: 44.0 Z: 14.0

MN-540M (リヤ)

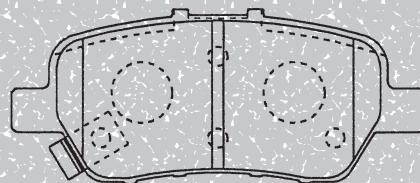

X: 108.9 Y: 41.5 Z: 13.5

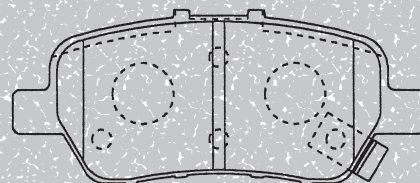

X: 108.9 Y: 41.5 Z: 13.5

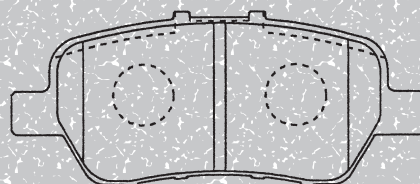

X: 108.9 Y: 41.5 Z: 13.5

BRAKE PADS

MN-541M

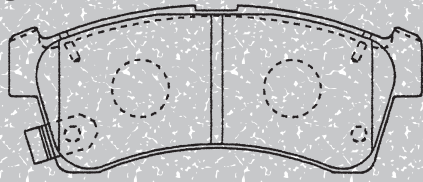

X: 108.6 Y: 36.0 Z: 14.0

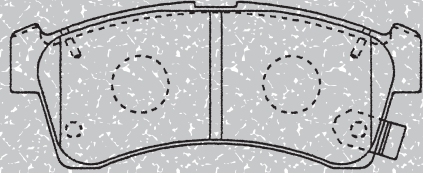

X: 108.6 Y: 36.0 Z: 14.0

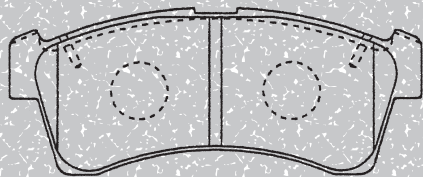

X: 108.6 Y: 36.0 Z: 14.0

MN-544

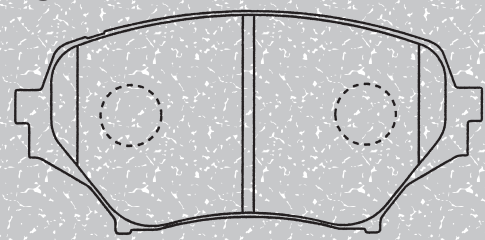

X: 123.0 Y: 54.0 Z: 14.0

MN-545M (リヤ)

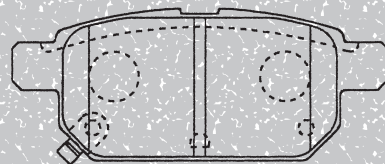

X: 98.6 Y: 38.5 Z: 14.0

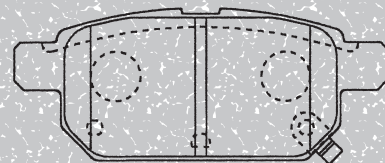

X: 98.6 Y: 38.5 Z: 14.0

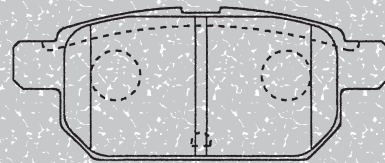

X: 98.6 Y: 38.5 Z: 14.0

MN-542M

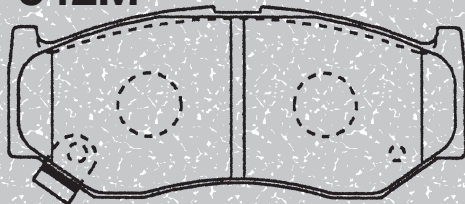

X: 108.6 Y: 40.5 Z: 14.5

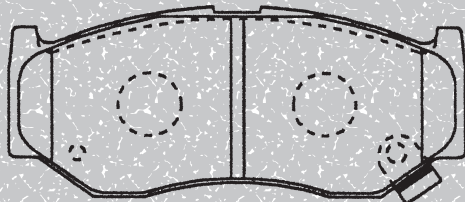

X: 108.6 Y: 40.5 Z: 14.5

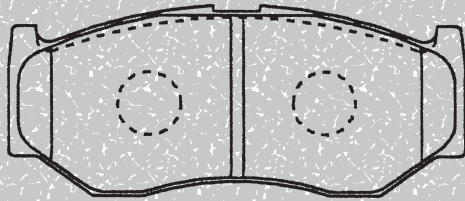

X: 108.6 Y: 40.5 Z: 14.5

MN-546

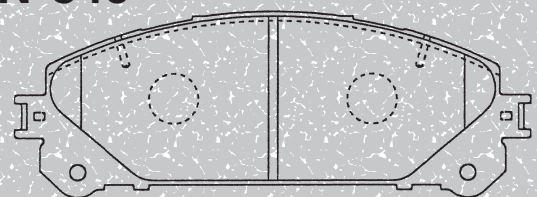

X: 167.0 Y: 55.5 Z: 17.0

MN-543 (リヤ)

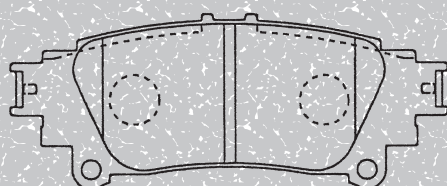

X: 115.2 Y: 38.5 Z: 16.5

MN-547 (リヤ)

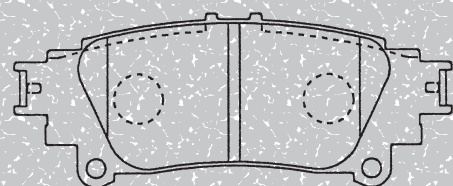

X: 115.2 Y: 38.5 Z: 14.5

BRAKE PADS

MN-548M (リヤ)

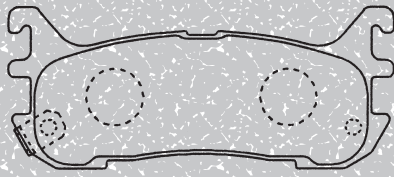

X: 102.0 Y: 31.5 Z: 12.5

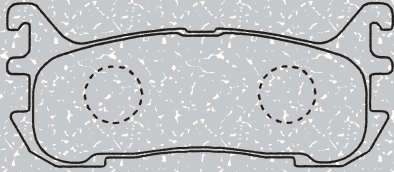

X: 102.0 Y: 31.5 Z: 12.5

MN-549 (リヤ)

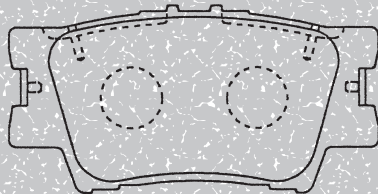

X: 96.9 Y: 44.5 Z: 15.0

MN-550M (フロント&リヤ)

X: 178.3
Y: 49.5
Z: 21.0

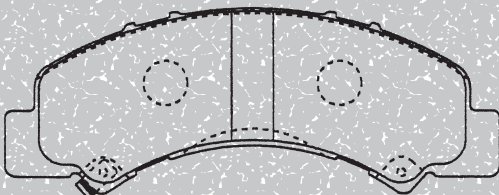

X: 178.3
Y: 49.5
Z: 21.0

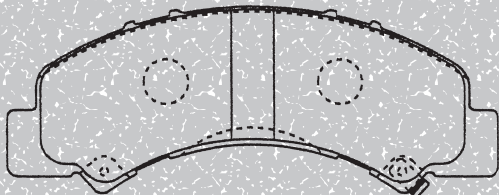

X: 178.3
Y: 49.5
Z: 21.0

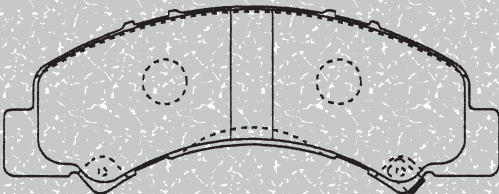

X: 178.3
Y: 49.5
Z: 21.0

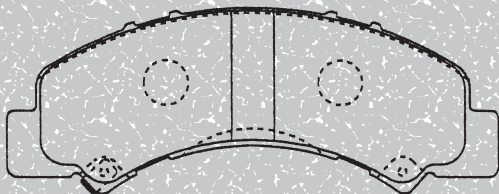

MN-551

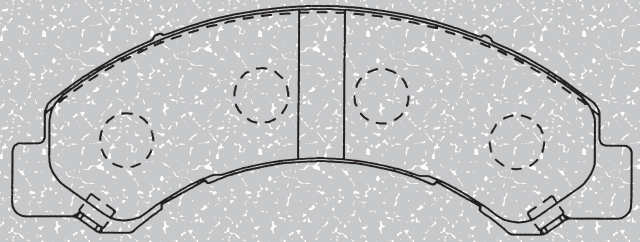

X: 206.3 Y: 51.0 Z: 21.0

MN-552M (フロント&リヤ)

X: 206.3
Y: 51.0
Z: 20.0

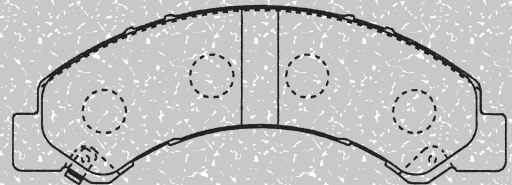

X: 206.3
Y: 51.0
Z: 20.0

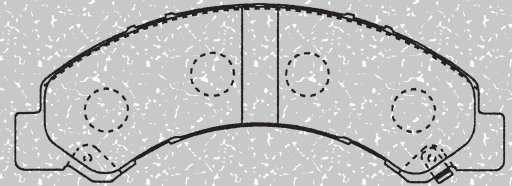

X: 206.3
Y: 51.0
Z: 20.0

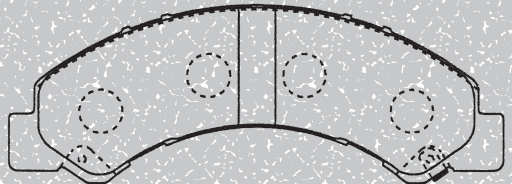

X: 206.3
Y: 51.0
Z: 20.0

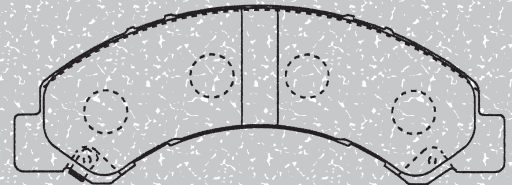

MN-553

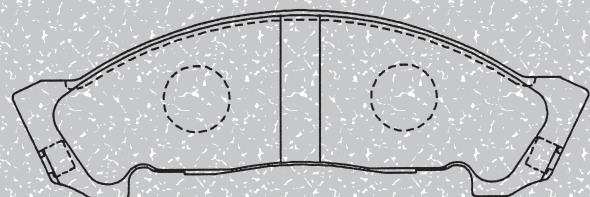

X: 191.2 Y: 51.0 Z: 19.0

BRAKE PADS

MN-554M (フロント&リヤ)

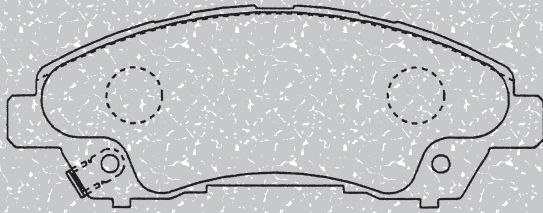

X: 153.5 Y: 50.7 Z: 18.0

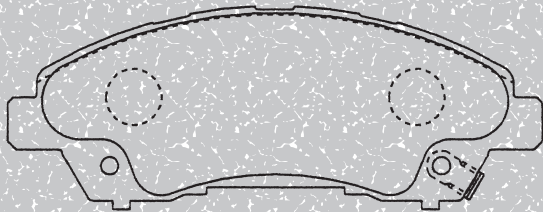

X: 153.5 Y: 50.7 Z: 18.0

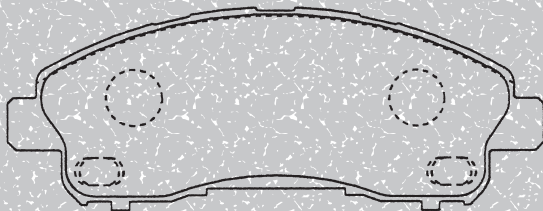

X: 153.5 Y: 50.7 Z: 18.0

MN-557M

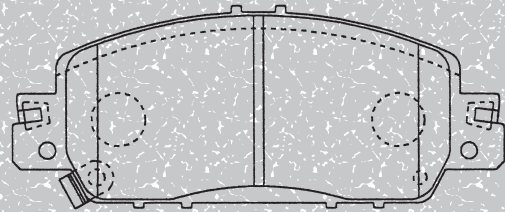

X: 148.8 Y: 57.5 Z: 16.5

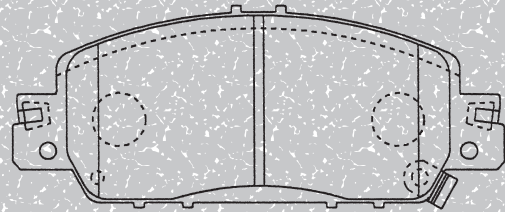

X: 148.8 Y: 57.5 Z: 16.5

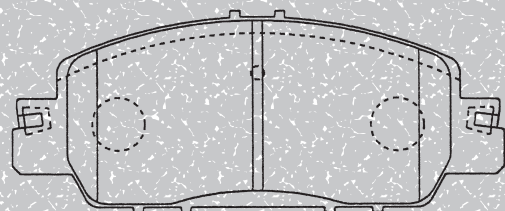

X: 148.8 Y: 57.5 Z: 16.5

MN-555

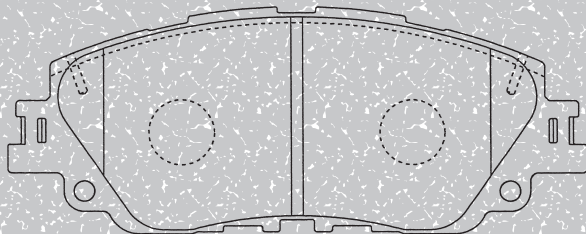

X: 142.7 Y: 51.0 Z: 16.5

MN-558 (リヤ)

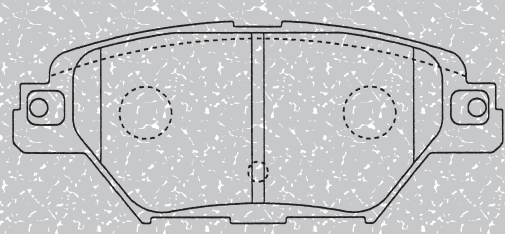

X: 122.2 Y: 49.0 Z: 14.0

MN-556

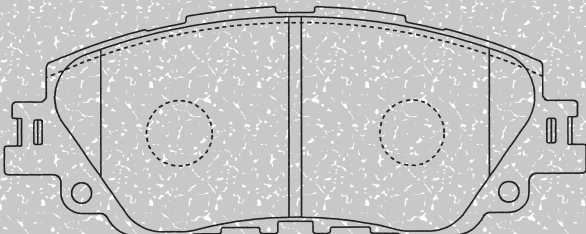

X: 142.7 Y: 51.0 Z: 16.5

MN-559M

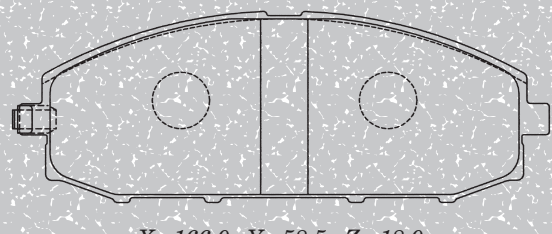

X: 166.0 Y: 58.5 Z: 18.0

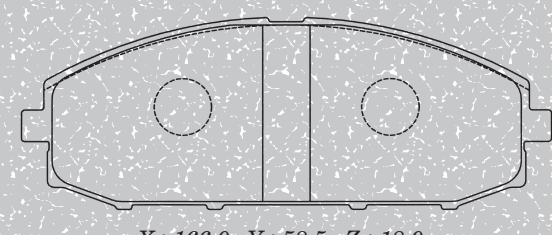

X: 166.0 Y: 58.5 Z: 18.0

センサー同梱

BRAKE PADS

MN-560M (リヤ)

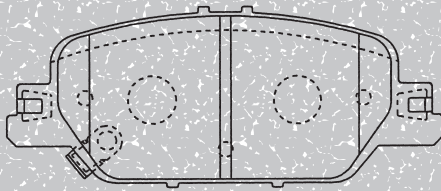

X: 119.0 Y: 49.2 Z: 16.0

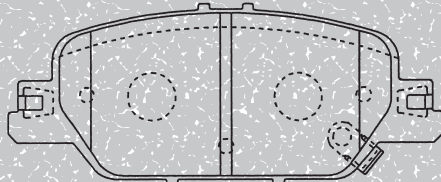

X: 119.0 Y: 49.2 Z: 16.0

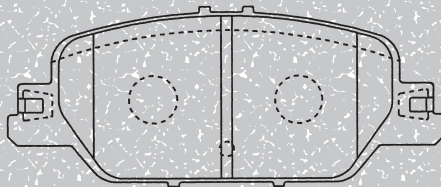

X: 119.0 Y: 49.2 Z: 16.0

MN-562 (リヤ)

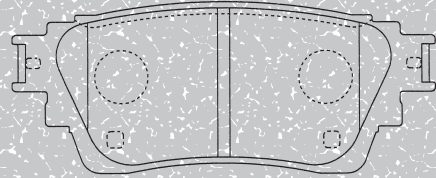

X: 103.6 Y: 39.5 Z: 13.5

MN-563

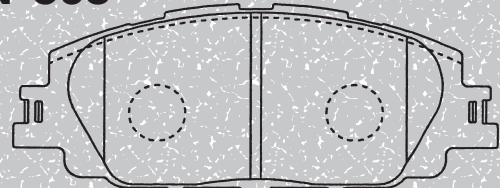

X: 139.7 Y: 53.0 Z: 16.0

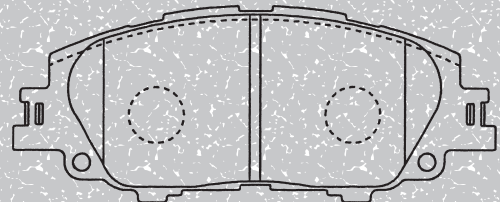

X: 139.7 Y: 50.0 Z: 16.0

MN-561M (リヤ)

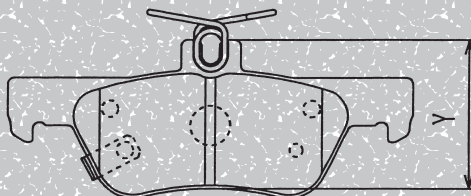

X: 122.5 Y: 45.0 Z: 13.5

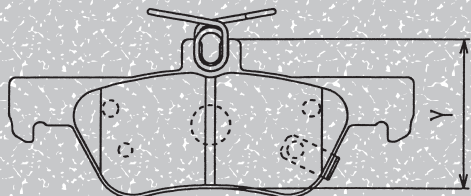

X: 122.5 Y: 45.0 Z: 13.5

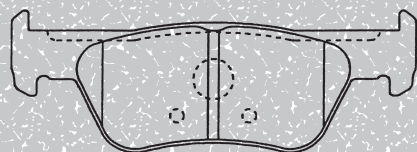

X: 122.5 Y: 36.0 Z: 13.5

スプリング同梱

MN-564M

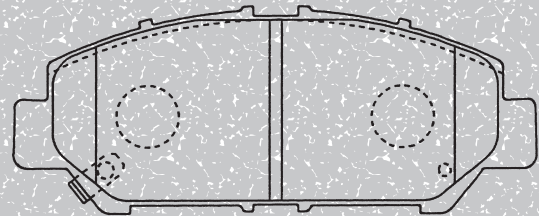

X: 126.9 Y: 45.8 Z: 15.0

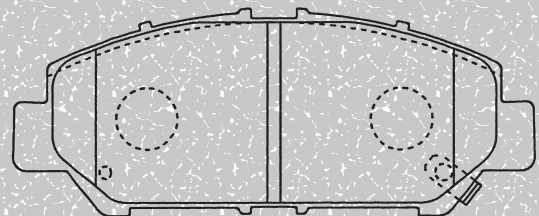

X: 126.9 Y: 45.8 Z: 15.0

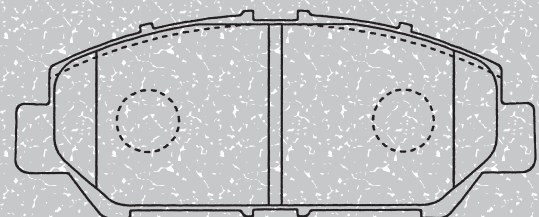

X: 126.9 Y: 45.8 Z: 15.0

BRAKE PADS

MN-565M

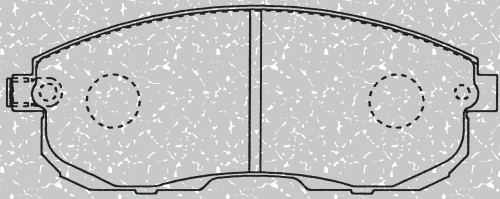

X: 137.0 Y: 48.0 Z: 15.5

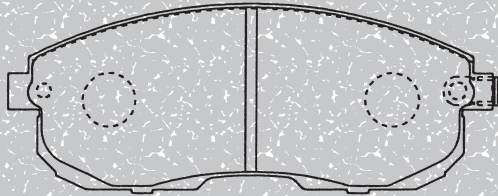

X: 137.0 Y: 48.0 Z: 15.5

MN-566 (リヤ)

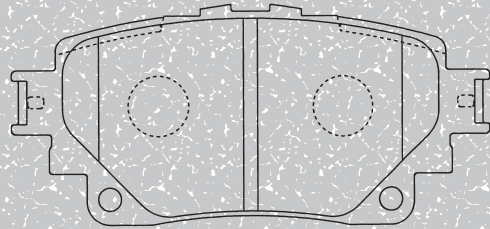

X: 103.6 Y: 44.0 Z: 14.5

MN-567M

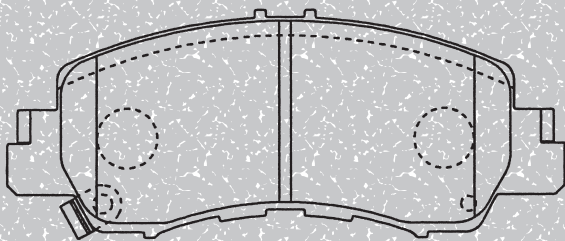

X: 148.8 Y: 51.5 Z: 15.5

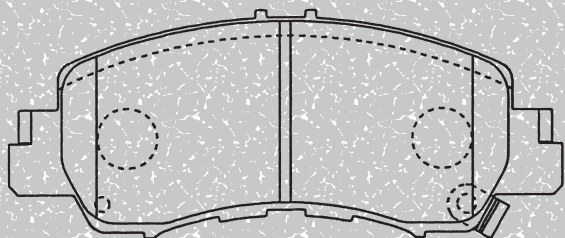

X: 148.8 Y: 51.5 Z: 15.5

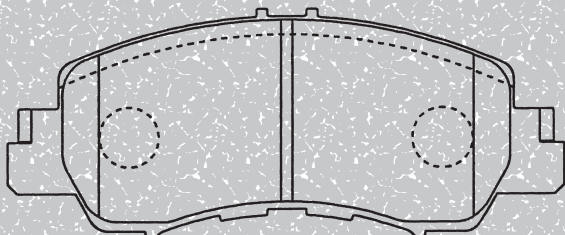

X: 148.8 Y: 51.5 Z: 15.5

MN-568M

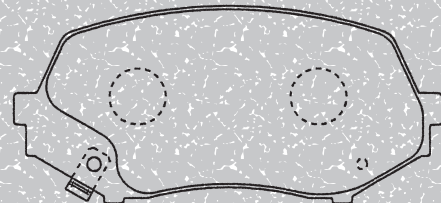

X: 123.0 Y: 52.0 Z: 17.5

1枚

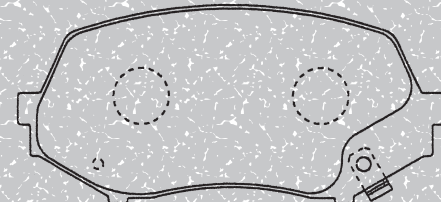

X: 123.0 Y: 52.0 Z: 17.5

1枚

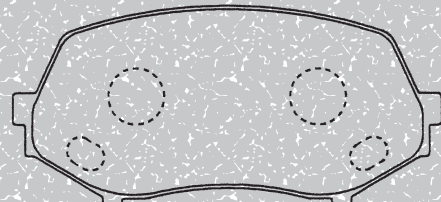

X: 123.0 Y: 52.0 Z: 17.5

6枚

MN-569M

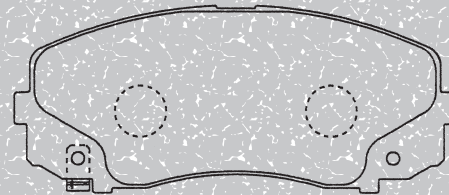

X: 139.0 Y: 52.0 Z: 19.5

1枚

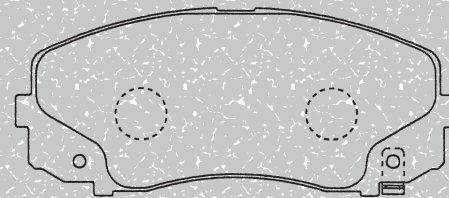

X: 139.0 Y: 52.0 Z: 19.5

1枚

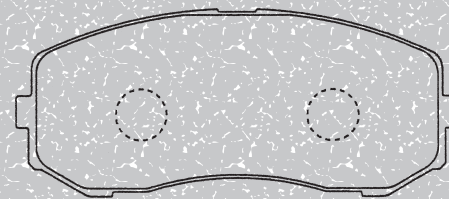

X: 139.0 Y: 52.0 Z: 19.5

6枚

BRAKE PADS

MN-570M (リヤ)

X: 104.0
Y: 43.5
Z: 14.0

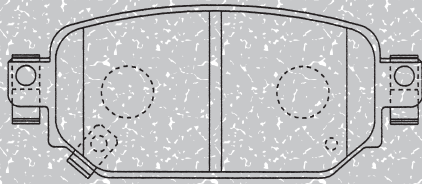

X: 104.0
Y: 43.5
Z: 14.0

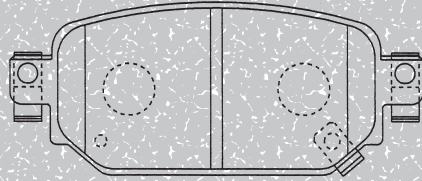

X: 104.0
Y: 43.5
Z: 14.0

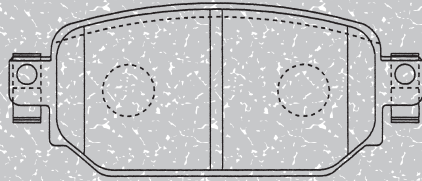

MN-571M

X: 110.5
Y: 40.7
Z: 15.0

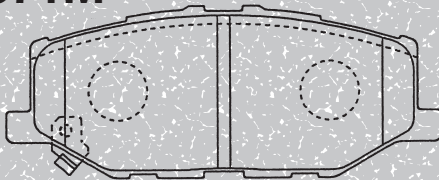

X: 110.5
Y: 40.7
Z: 15.0

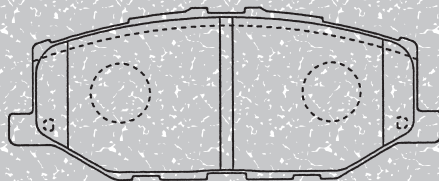

MN-572M

X: 142.0
Y: 54.5
Z: 15.5

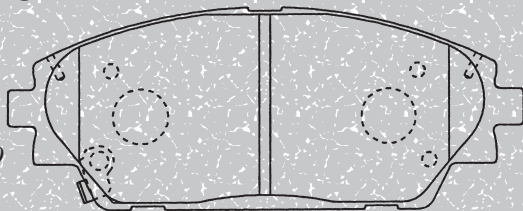

X: 142.0
Y: 54.5
Z: 15.5

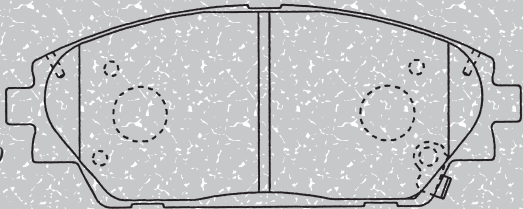

X: 142.0
Y: 54.5
Z: 15.5

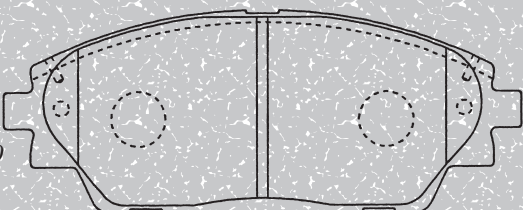

MN-573 (リヤ)

X: 88.7 Y: 33.0 Z: 13.0



X: 88.7 Y: 33.0 Z: 13.0

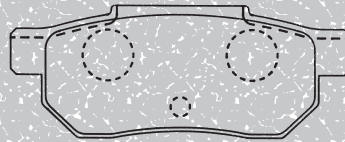

MN-574 (フロント&リヤ)

X: 153.5 Y: 50.7 Z: 18.0

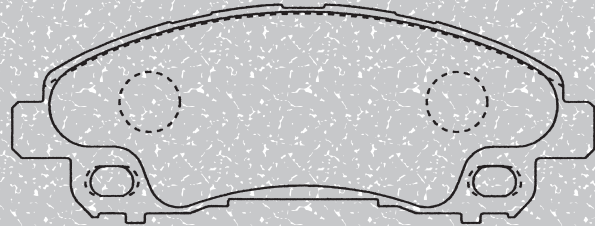

X: 153.5 Y: 50.7 Z: 18.0

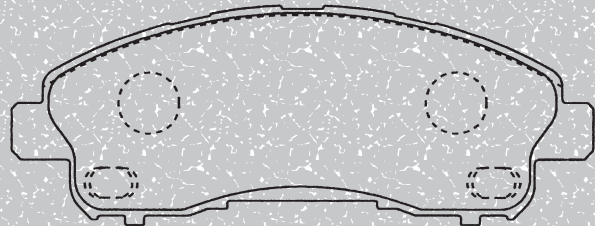

MN-575M

X: 138.0 Y: 54.5 Z: 15.5

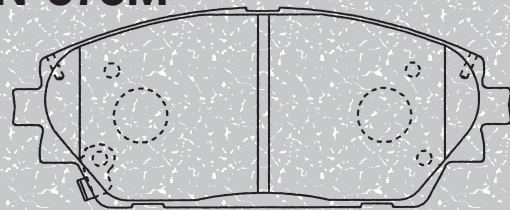

X: 138.0 Y: 54.5 Z: 15.5

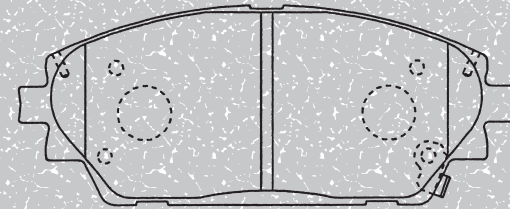

X: 138.0 Y: 54.5 Z: 15.5

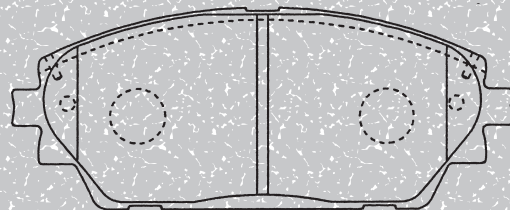

BRAKE PADS

MN-576M (フロント&リヤ)

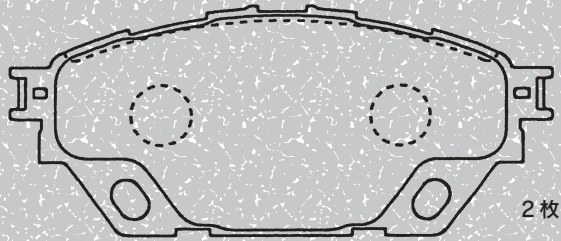

X: 144.3 Y: 59.8 Z: 19.5

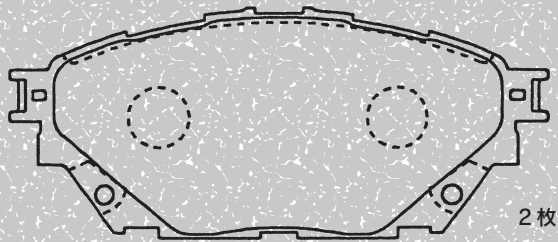

X: 144.3 Y: 58.2 Z: 19.5

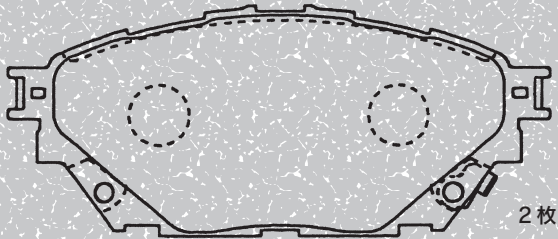

X: 144.3 Y: 58.2 Z: 19.5

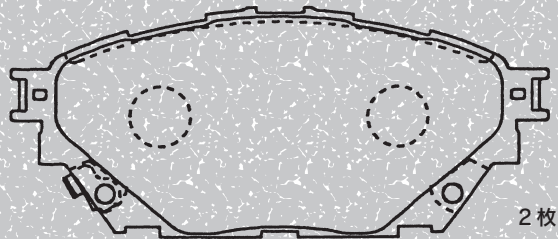

X: 144.3 Y: 58.2 Z: 19.5

MN-577

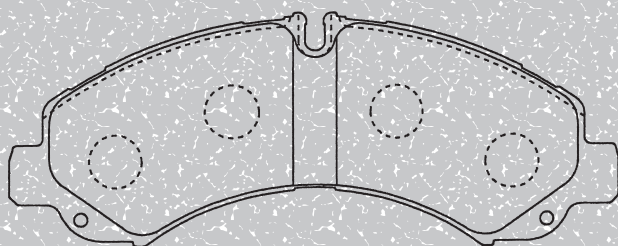

X: 184.2 Y: 41.3 Z: 19.5

MT-002M

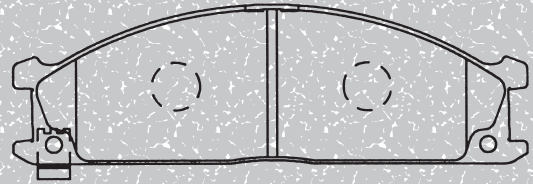

X: 160.7 Y: 48.5 Z: 17.0

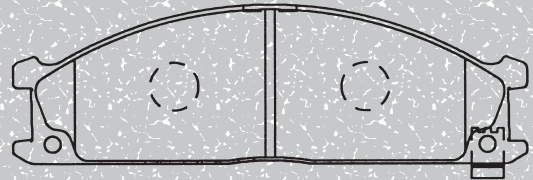

X: 160.7 Y: 48.5 Z: 17.0

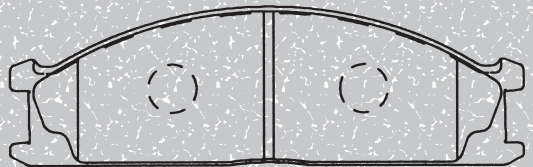

X: 160.7 Y: 48.5 Z: 17.0

MT-004

タクシー専用アイテムです。

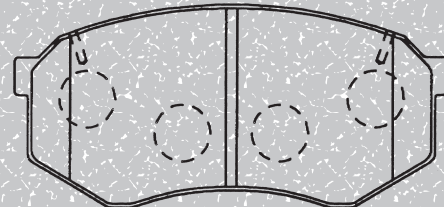

X: 116.0 Y: 49.0 Z: 18.0

MN-205と似ていますが、互換性はありません。